

Unit abbreviations (F) : FRONT UNIT (C) : CHASSIS PARTS (PB) : PBT BOARD
 (RI) : RIT BOARD (DIS) : DISPLAY BOARD (MI) : MIC BOARD
 (KE) : KEY BOARD (PH) : PHONE BOARD

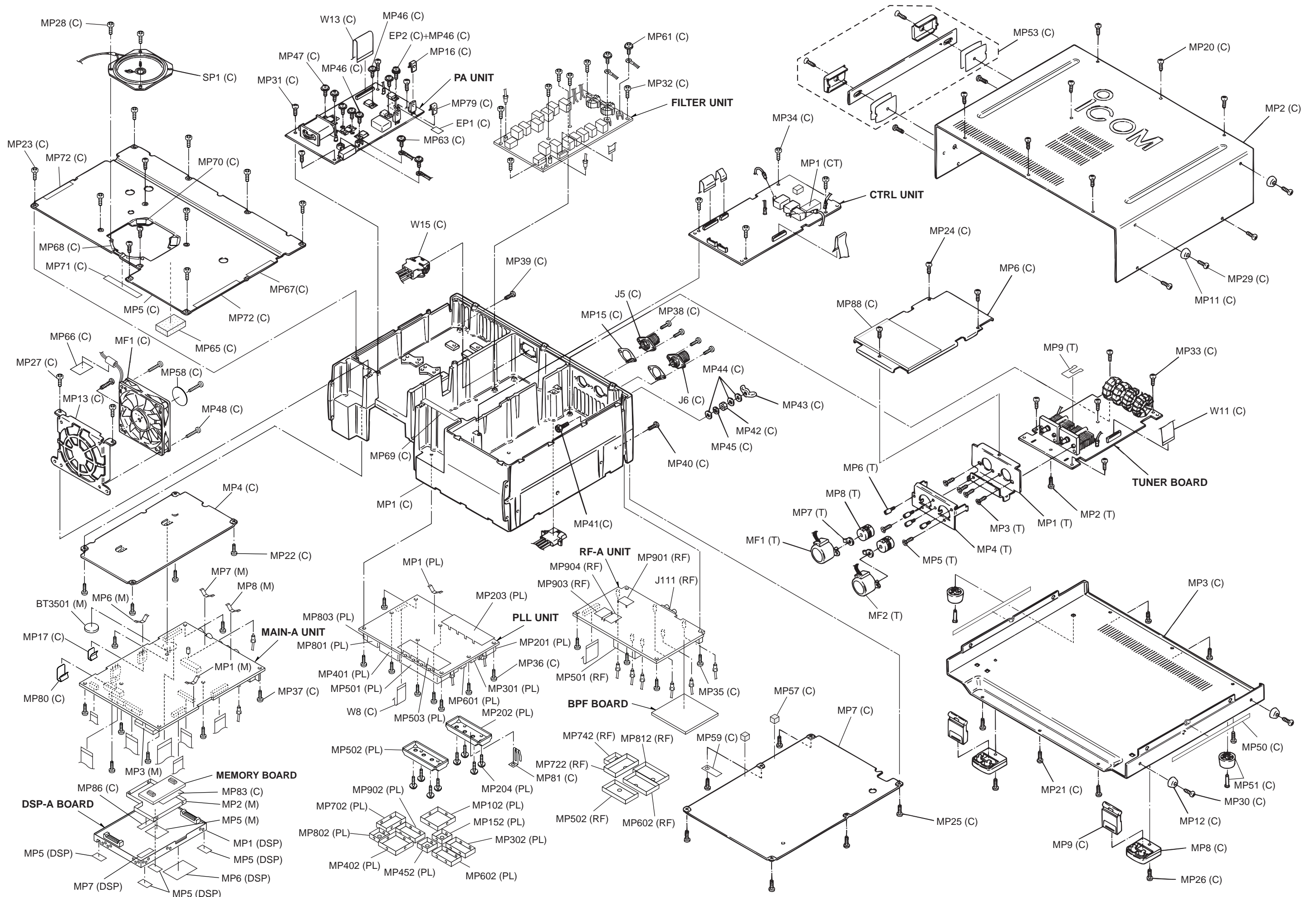

Unit abbreviations (C) : CHASSIS PARTS (M) : MAIN-A UNIT (RF) : RF-A UNIT (T) : TUNER BOARD
 (PL) : PLL UNIT (DSP) : DSP-A BOARD (CT) : CTRL UNIT

[CHASSIS PARTS]

REF. NO.	ORDER NO.	DESCRIPTION	QTY.
MP29	8810001650	Screw PH FT M3 × 6	2
MP30	8810001650	Screw PH FT M3 × 6	2
MP31	8810008660	Screw PH BT M3 × 8 NI-ZU	4
MP32	8810008660	Screw PH BT M3 × 8 NI-ZU	7
MP33	8810008660	Screw PH BT M3 × 8 NI-ZU	5
MP34	8810008660	Screw PH BT M3 × 8 NI-ZU	4
MP35	8810008660	Screw PH BT M3 × 8 NI-ZU	4
MP36	8810008660	Screw PH BT M3 × 8 NI-ZU	8
MP37	8810008660	Screw PH BT M3 × 8 NI-ZU	7
MP38	8810008660	Screw PH BT M3 × 8 NI-ZU	4
MP39	8810008660	Screw PH BT M3 × 8 NI-ZU	1
MP40	8810008660	Screw PH BT M3 × 8 NI-ZU	1
MP41	8810008160	Hex volt M5 × 18 NI (+)	1
MP42	8830000210	Nut M5 NI BS	1
MP43	8830000360	Wing nut M5 NI	1
MP44	8850000150	Flat washer M5 NI BS	3
MP45	8850000440	Spring washer M5 NI	1
MP46	8810003170	Setscrew A M3 × 8	4
MP47	8810003170	Setscrew A M3 × 8	4
MP48	8810000420	Screw PH M4 × 18	4
MP49	8810009310	Screw FH BT M3 × 6 NI-ZU	4
MP50	8930048120	Shield tape (A) 120 × 9	2
MP51	8930042690	Rubber foot (L)	2
MP53	8010018060	Carrying handle (A)	1
MP57	8930027900	Sponge (DD)	2
MP58	8930038820	Aluminum sheet (V)	1
MP59	8930001170	Earth spring (A)	1
MP61	8810003160	Setscrew A M3 × 6	2
MP63	8810003160	Setscrew A M3 × 6	2
MP65	8930043281	Sponge (EW)-1	1
MP66	8930043800	Double coated tape (S)	1
MP67	8930029050	Non-woven sheet (AL)	1
MP68	8930032130	Non-woven sheet (AQ)	2
MP69	8930029050	Non-woven sheet (AL)	1
MP70	8930008670	Sponge (AQ)	2
MP71	8930043490	Sponge (FB)	1
MP72	8930007840	Non-woven sheet (K)	2
MP73	8930043600	Sponge (FE)	1
MP74	8930043480	Sponge (FA)	1
MP75	8930041160	Non-woven sheet (BO)	1
MP76	8930037830	Sponge (ED)	2
MP77	8930007840	Non-woven sheet (K)	4
MP79	8930035240	1546 TR-B crip	1
MP80	8930027940	1126 TR-B crip	1
MP81	8930017260	758 module earth spring	1
MP83	8930043090	Sponge (EV)	1
MP85	8930049130	Shield tape (D) 20 × 9	2
MP86	8930052100	Shield sponge (C)	1
MP88	8930054550	Insulation sheet (GL)	1

[MAIN-A UNIT]

REF. NO.	ORDER NO.	DESCRIPTION	QTY.
BT3501	3020000110	Lithium battery CR2032	1
J351	6450000140	Connector HSJ0807-01-010	1
J661	6450000170	Connector TCS4480-01-1111	1
J662	6450000160	Connector TCS4470-01-1111	1
J681	6450001490	Connector HLJ7001-01-3010	1
J691	6450001130	Connector JPL2042-01-110	1
J701	6450000140	Connector HSJ0807-01-010	1
MP1	8930014140	Earth spring (D)	1
MP2	8510012880	2178 A-shield cover assembly	1
MP3	8510012780	2178 A-shield case	1
MP5	8930032290	Sponge (DQ)	1
MP6	8930014140	Earth spring (D)	1
MP7	8930014140	Earth spring (D)	1
MP8	8930014140	Earth spring (D)	1

[DSP-A UNIT]

REF. NO.	ORDER NO.	DESCRIPTION	QTY.
MP1	8510012573	2178 DSP case-3	1
MP5	8930043440	Sponge (EY)	4
MP6	8930052890	Shield tape (G)	1
MP7	8930027700	Insulation sheet (E)	1

[RF-A UNIT]

REF. NO.	ORDER NO.	DESCRIPTION	QTY.
J111	6450001130	Connector JPJ2042-01-110	1
MP501	8510000230	220 shield case	1
MP502	8510000241	220 shield cover-1	1
MP601	8510000230	220 shield case	1
MP602	8510000241	220 shield cover-1	1
MP721	8510000230	220 shield case	1
MP722	8510000241	220 shield cover-1	1
MP741	8510005150	602 shield case	1
MP742	8510005160	602 shield cover	1
MP811	8510000230	220 shield case	1
MP812	8510000241	220 shield cover-1	1
MP901	8510002280	VCO shield plate (A)	1
MP903	8510002280	VCO shield plate (A)	1
MP904	8510002280	VCO shield plate (A)	1

[CTRL UNIT]

REF. NO.	ORDER NO.	DESCRIPTION	QTY.
MP1	8510002020	MIX shield case	1

[PLL UNIT]

REF. NO.	ORDER NO.	DESCRIPTION	QTY.
MP1	8930014140	Earth spring (D)	1
MP51	8510000230	220 shield case	1
MP101	8510010760	1876 DDS case	1
MP102	8510010770	1876 DDS cover	1
MP103	8510005330	Coil case	1
MP151	8510012550	2178 DDS case	1
MP152	8510012580	2178 DDS cover	1
MP201	8510012540	2178 VCO case	1
MP202	8510011520	2072 VCO cover	1
MP203	8510011710	2072 VCO shield plate	1
MP204	8810003960	Setscrew A M2.6 × 5	8
MP301	8510005980	724 shield case	1
MP302	8510005990	724 shield cover	1
MP401	8510010760	1876 DDS case	1
MP402	8510010770	1876 DDS cover	1
MP403	8510005330	Coil case	1
MP451	8510012550	2178 DDS case	1
MP452	8510012580	2178 DDS cover	1
MP501	8510012540	2178 VCO case	1
MP502	8510011520	2072 VCO cover	1
MP503	8510011710	2072 VCO shield plate	1
MP601	8510005980	724 shield case	1
MP602	8510005990	724 shield cover	1
MP701	8510005980	724 shield case	1
MP702	8510005990	724 shield cover	1
MP801	8510012550	2178 DDS case	1
MP802	8510012580	2178 DDS cover	1
MP803	8510012400	2177 D/A case	1
MP901	8510005980	724 shield case	1
MP902	8510005990	724 shield cover	1

[TUNER BOARD]

REF. NO.	ORDER NO.	DESCRIPTION	QTY.
MF1	2710000460	Motor MP28GA	1
MF2	2710000460	Motor MP28GA	1
MP1	8930041090	1876 A-angle	1
MP2	8810008660	Screw PH BT M3 × 8 NI-ZU	1
MP3	8810009060	Screw FH M3 × 6 ZK	4
MP4	8930041110	1876 B-angle	1
MP5	8810009060	Screw FH M3 × 6 ZK	2
MP6	8820000880	1528 screw	4
MP7	8930030111	1414 plate-1	2
MP8	8950003200	UJ6-5 (universal couplings)	2
MP9	8930051580	2178 tuner plate	1

[UNPACKING]

REF. NO.	ORDER NO.	DESCRIPTION	QTY.
F1	5210000090	Fuse FGB 30A	2
F2	5210000060	Fuse FGB 5A	1
MC1	Optional product	Hand microphone HM-36	1
W1	Optional product	DC power cable OPC-025D	1

Screw abbreviations BT: Self-tapping B0: Self-tapping
 FT: Self-tapping PH: Pan head
 FH: Flat head BiH: Bind head
 NI-ZU: Nickel-zinc NI: Nickel
 BS: Brass ZK:Black

SECTION 7 SEMI-CONDUCTOR INFORMATION

• TRANSISTORS AND FET'S

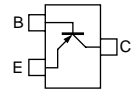
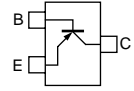
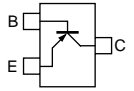
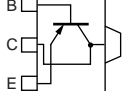
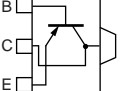
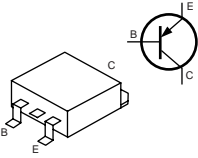
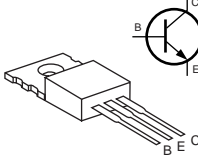
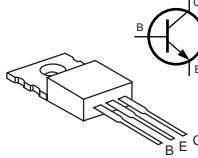
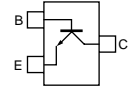
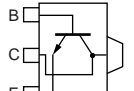
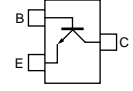
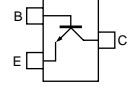
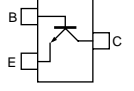
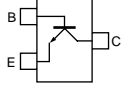
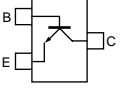
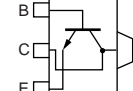
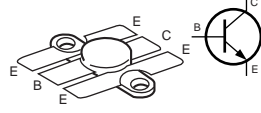
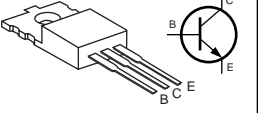
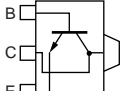
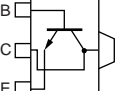
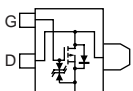
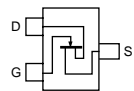
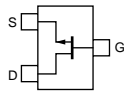
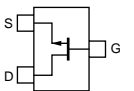
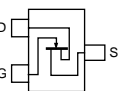
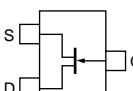
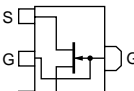
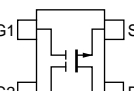
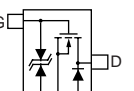
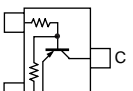
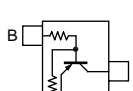
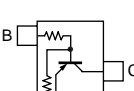
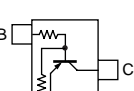
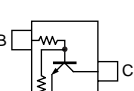
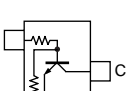
2SA1162 GR (Symbol: SG) 	2SA1576A T106 R (Symbol: FR) 	2SA1577 (Symbol: HP) 	2SB1124 S TD (Symbol: BG) 	2SB1132 T100 R (Symbol: BAR) 
2SB1201 S (Symbol: B1201) 	2SC1971 (Symbol: None) 	2SC1972 (Symbol: None) 	2SC2714 O (Symbol: QO) 	2SC3647 S TD (Symbol: CC) 
2SC4081 T107 R (Symbol: BR) 	2SC4117 GR (Symbol: DG) 	2SC4213 B (Symbol: AB) 	2SC4403 3 TL (Symbol: LY3) 	2SC4405 3 TL (Symbol: OY3) 
2SC4673 D TD (Symbol: CO) 	2SC5125 	2SD1585 K (Symbol: None) 	2SD1619 T TD (Symbol: DB) 	2SD1801 S TL (Symbol: CE) 
2SJ381 TD (Symbol: JI) 	2SK210 GR (Symbol: YG) 	2SK508 K52 T2B (Symbol: K52) 	2SK515 T1B (Symbol: X33) 	2SK882 GR (Symbol: TGR) 
2SK1740 (Symbol: IJ) 	2SK2171 4 TD (Symbol: KM) 	3SK131 T2 MAS (Symbol: V11) 	CPH3404-TL (Symbol: KD) 	DTA114 EE TL (Symbol: 14) 
DTA114EUA T106 (Symbol: 14) 	DTA144 EE TL (Symbol: 16) 	DTB123 EK T147 (Symbol: F12) 	DTC114 EE TL (Symbol: 24) 	DTC114EUA T106 (Symbol: 24) 

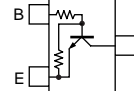
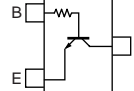
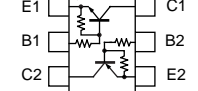
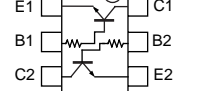
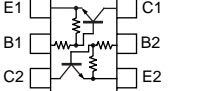
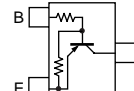
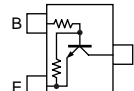
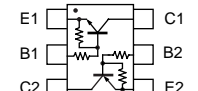
DTC144 EE TL (Symbol: 26) 	DTC144 TE (Symbol: 06) 	UMD3 N TL (Symbol: D3) 	UMH4N TN (Symbol: H4) 	UMH11N TN (Symbol: H11) 
UN911H (Symbol: 6P) 	UN9211 (Symbol: 8A) 	XP4311 (Symbol: 3X) 		

8-2 DISPLAY BOARD (TOP VIEW)

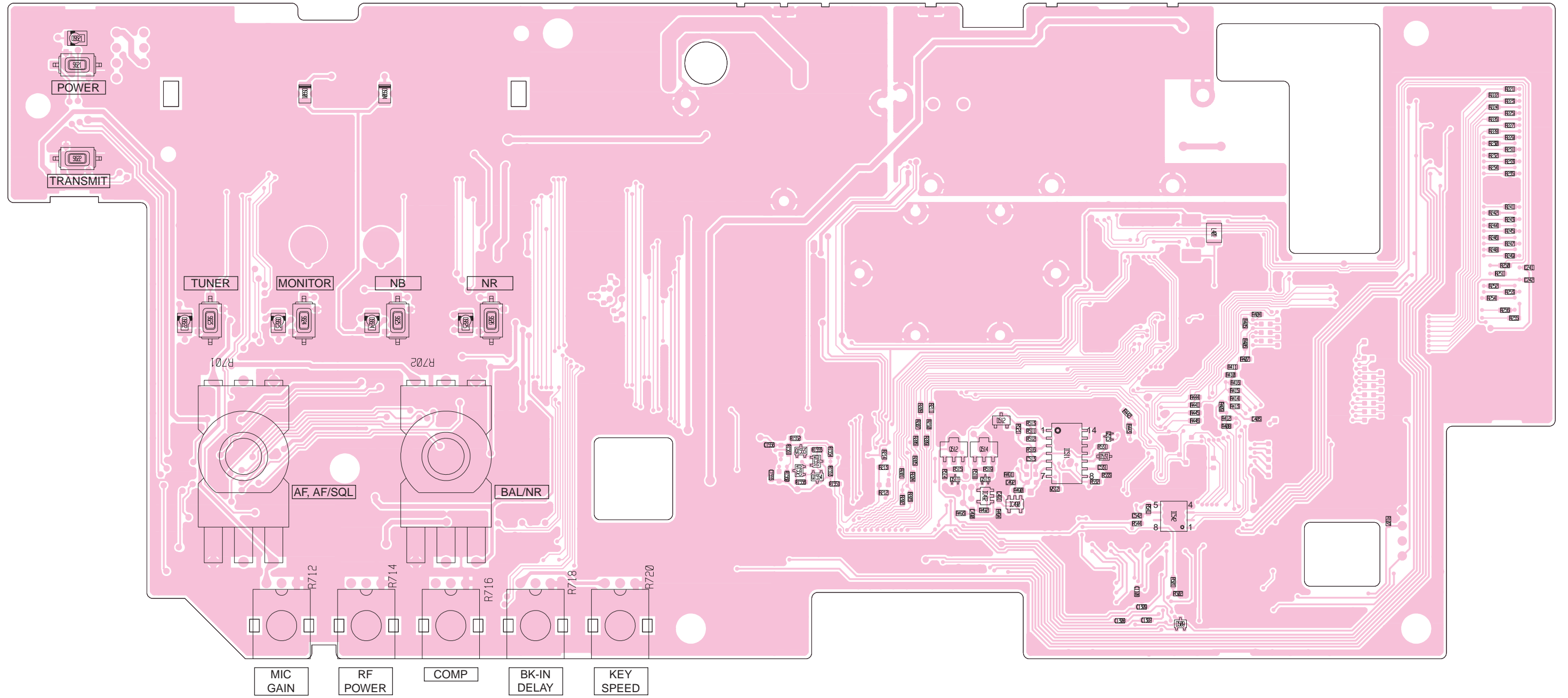

• DISPLAY BOARD (BOTTOM VIEW)

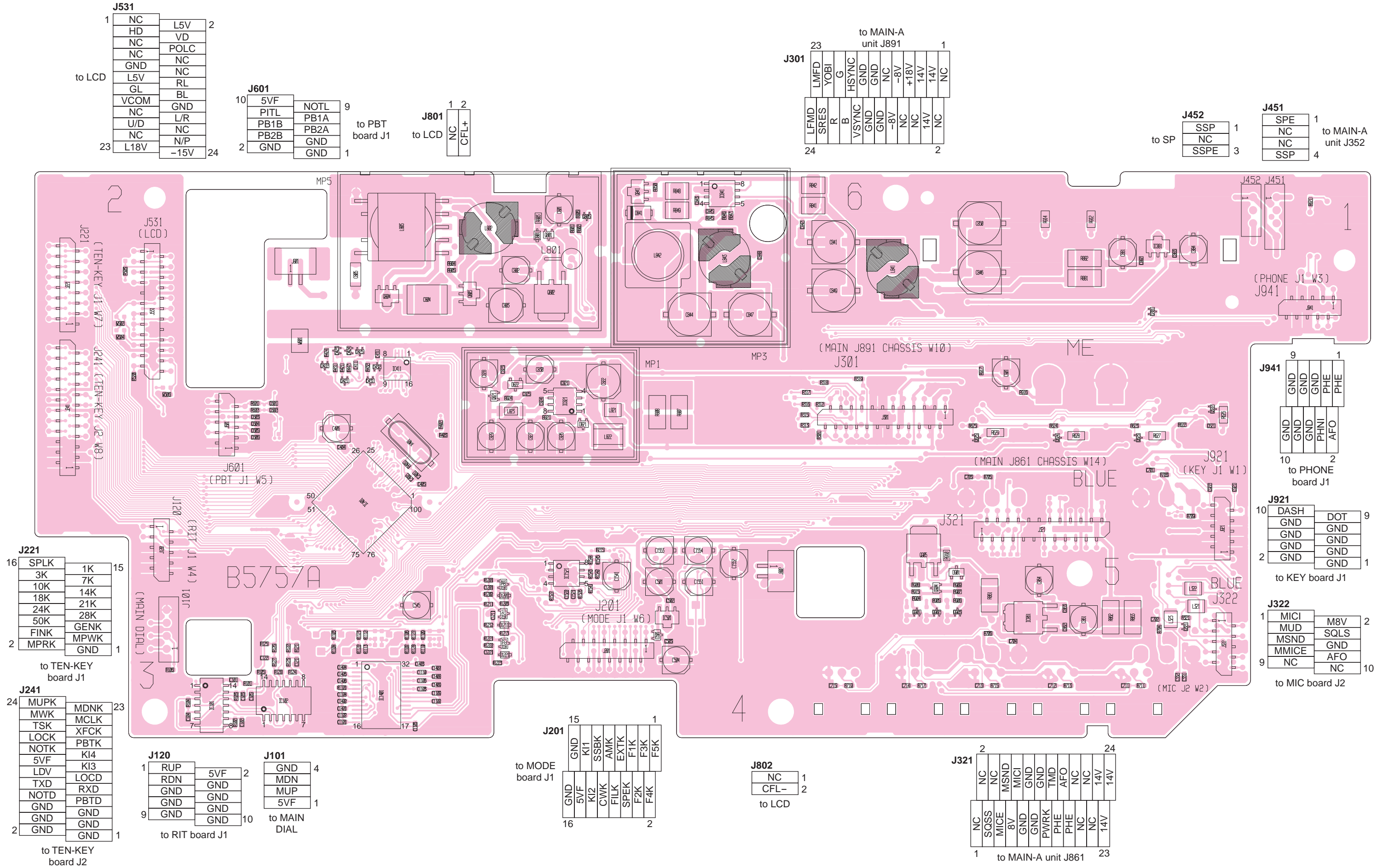

8-3 MODE, PHONE, KEY AND TEN-KEY BOARDS

• MODE BOARD (TOP VIEW)

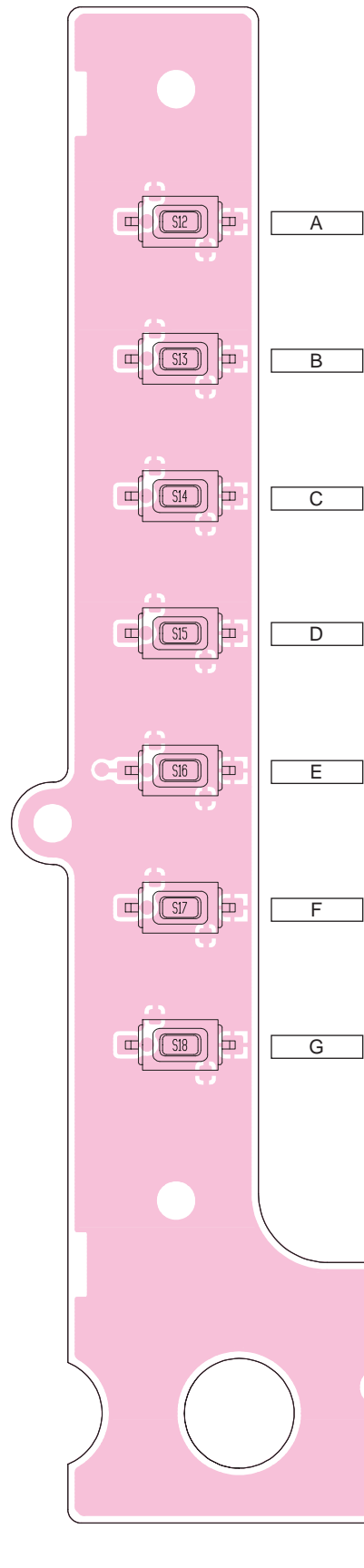

• PHONE BOARD

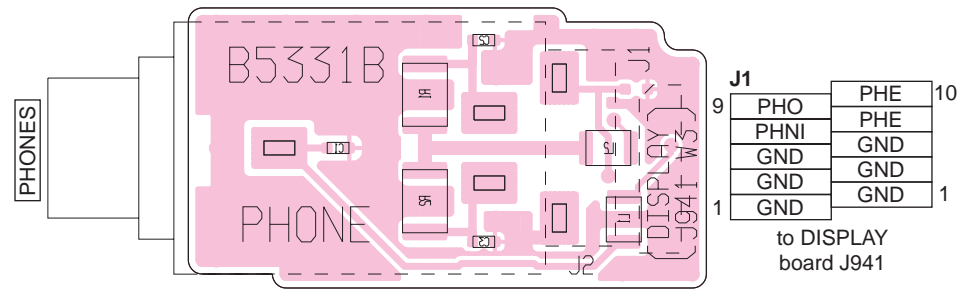

• KEY BOARD

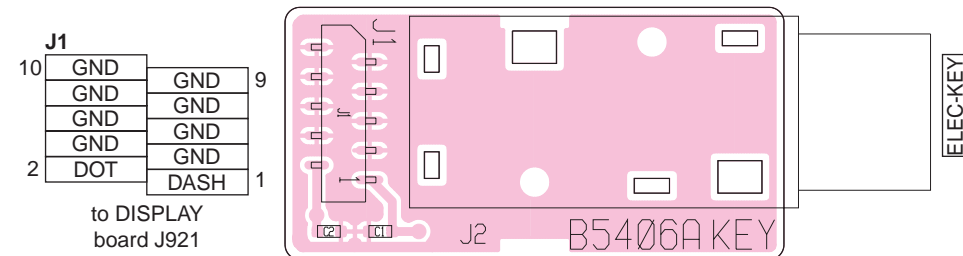

• TEN-KEY BOARD (TOP VIEW)

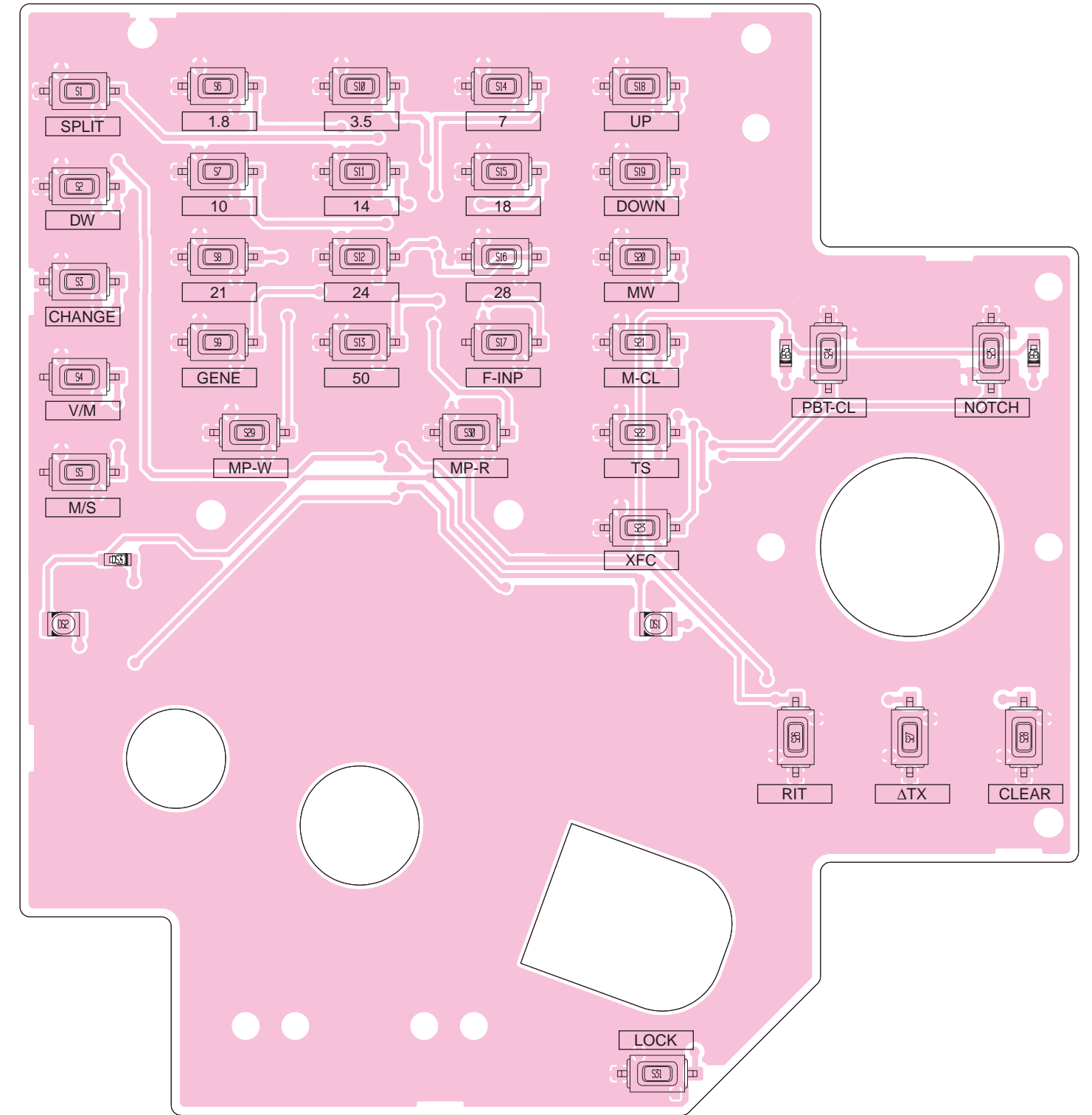

• TEN-KEY BOARD (BOTTOM VIEW)

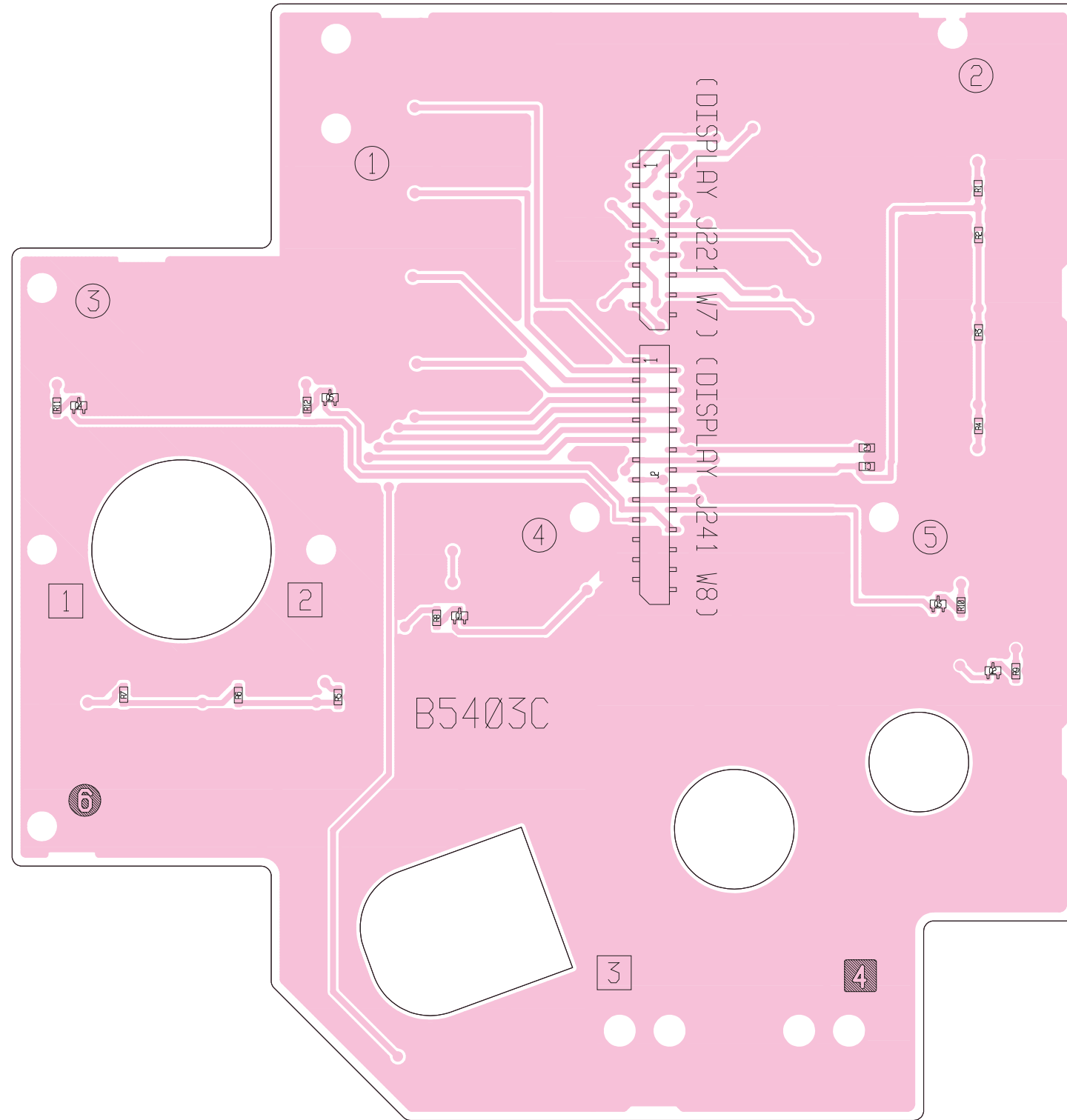

J1

1	SPLK	1K	2
	3K	7K	
	10K	14K	
	18K	21K	
	24K	28K	
	50K	GENK	
	FINK	MPWK	
15	MPRK	GND	16

to DISPLAY board J221

J2

1	MUPK	MDNK	2
	MWK	MCLK	
	TSK	XFCK	
	LOCK	PBTK	
	NOTK	KI4	
	5VF	KI3	
	LDV	LOCD	
	TXD	RXD	
	NOTD	PBTD	
	GND	GND	
	GND	GND	
23	GND	GND	24

to DISPLAY board J241

to DISPLAY board J201

2	GND	16
	KI1	
	SSBK	
	AMK	
	EXTK	
	F1K	
	F3K	
	F5K	
1	GND	15
	5VF	
	KI2	
	CWK	
	FILK	
	SPEK	
	F2K	
	F4K	

• MODE BOARD (BOTTOM VIEW)

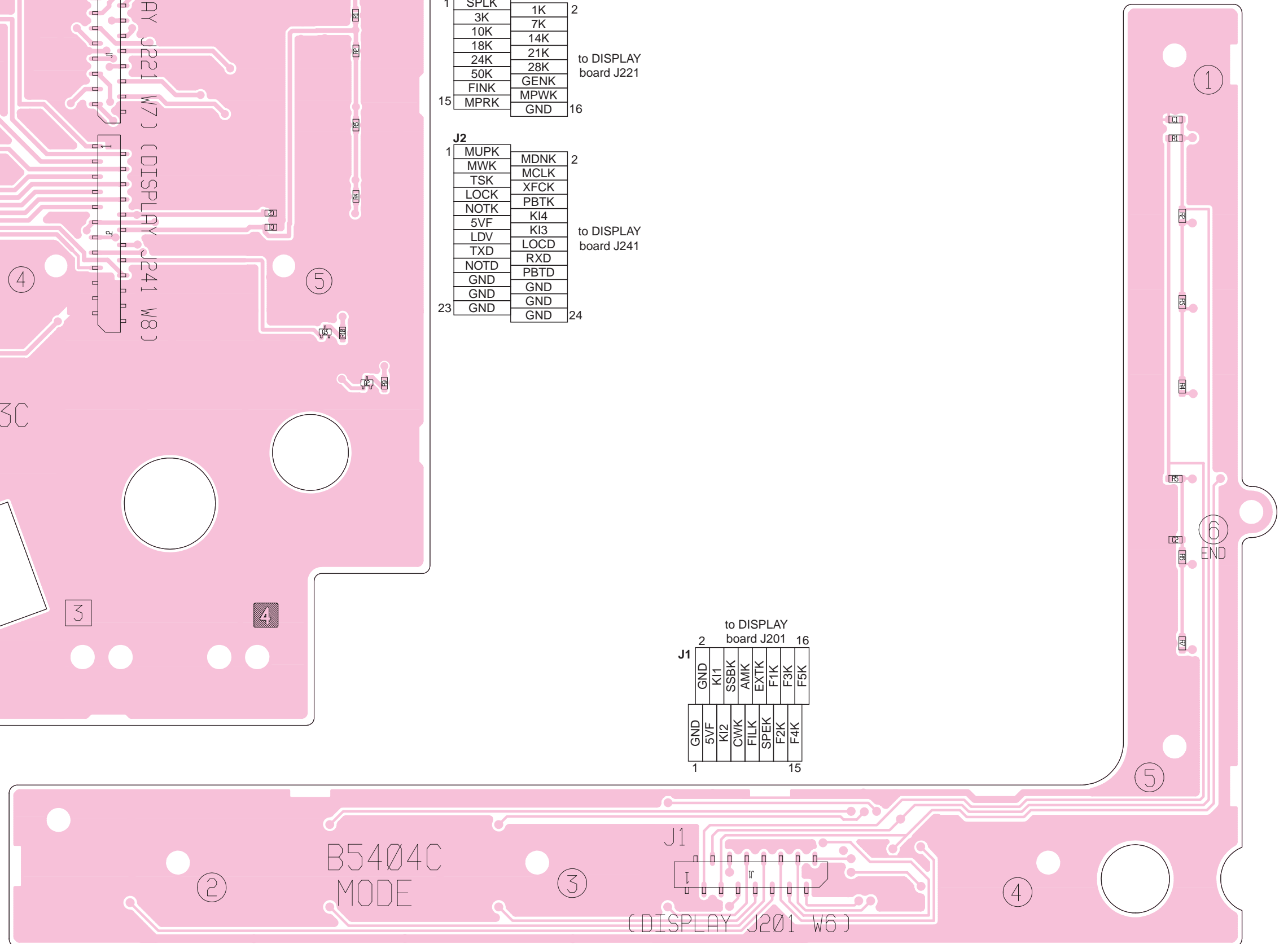

8-4 RF-A UNIT (TOP VIEW)

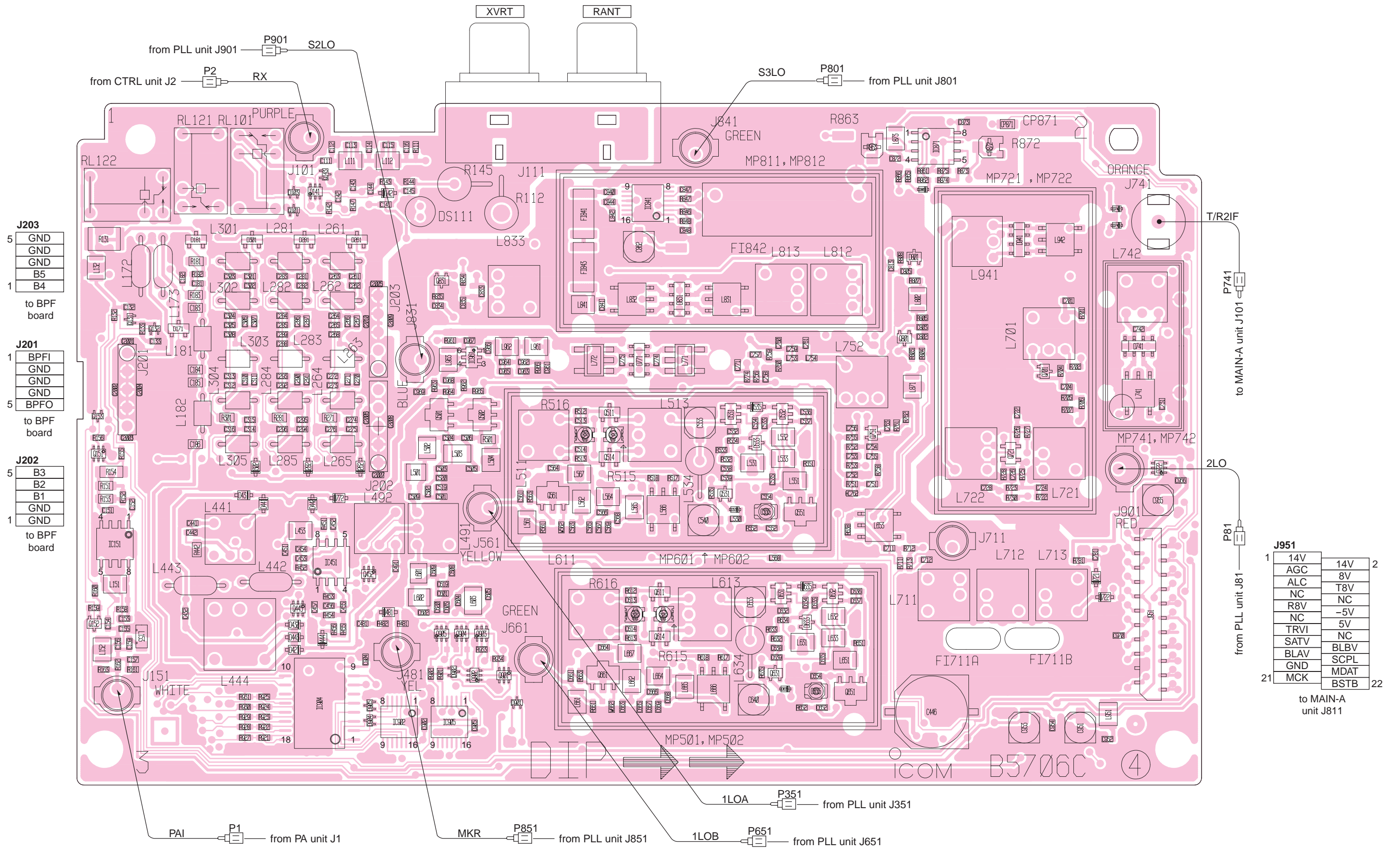

• RF-A UNIT (BOTTOM VIEW)

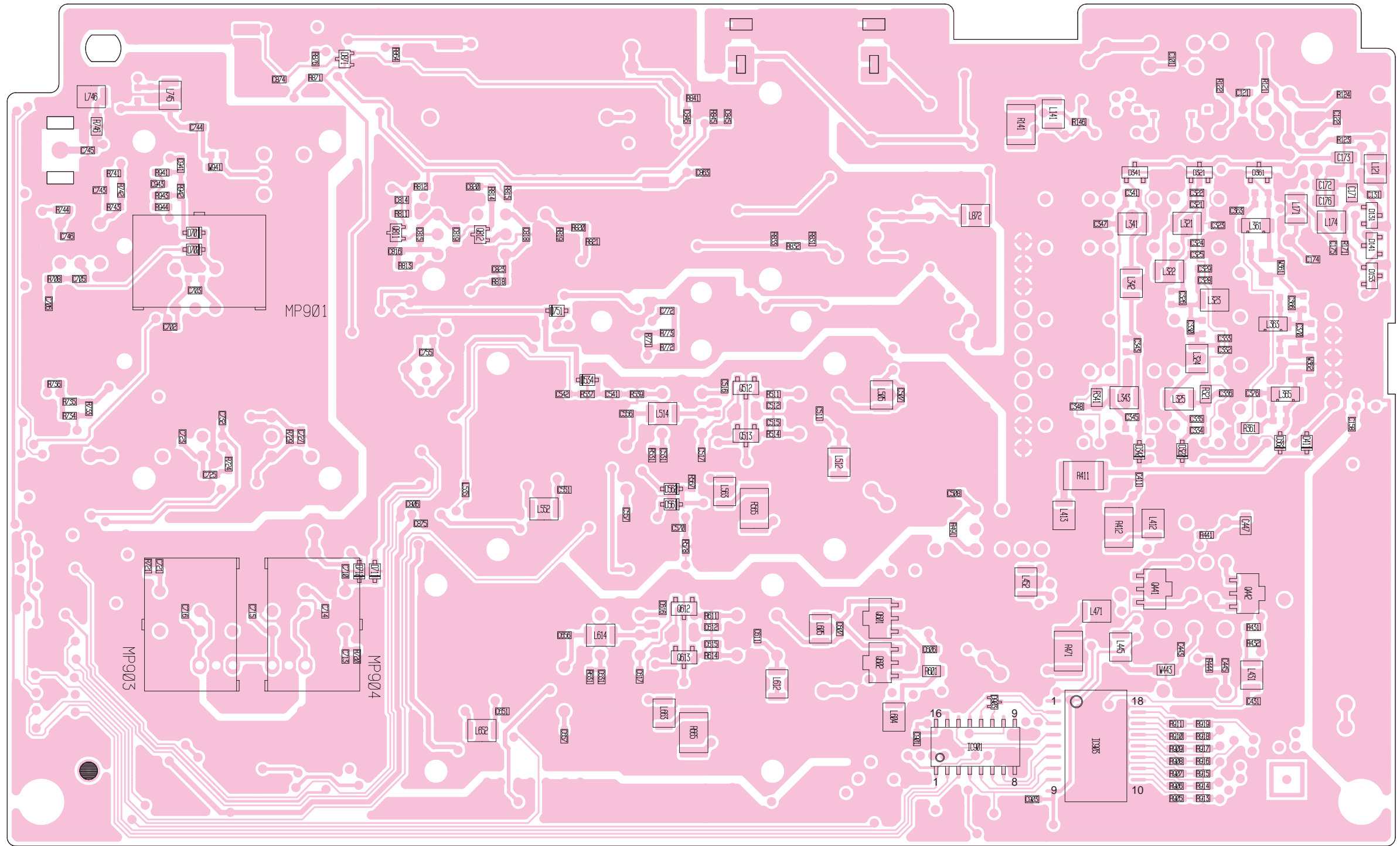

8-5 PLL UNIT (TOP VIEW)

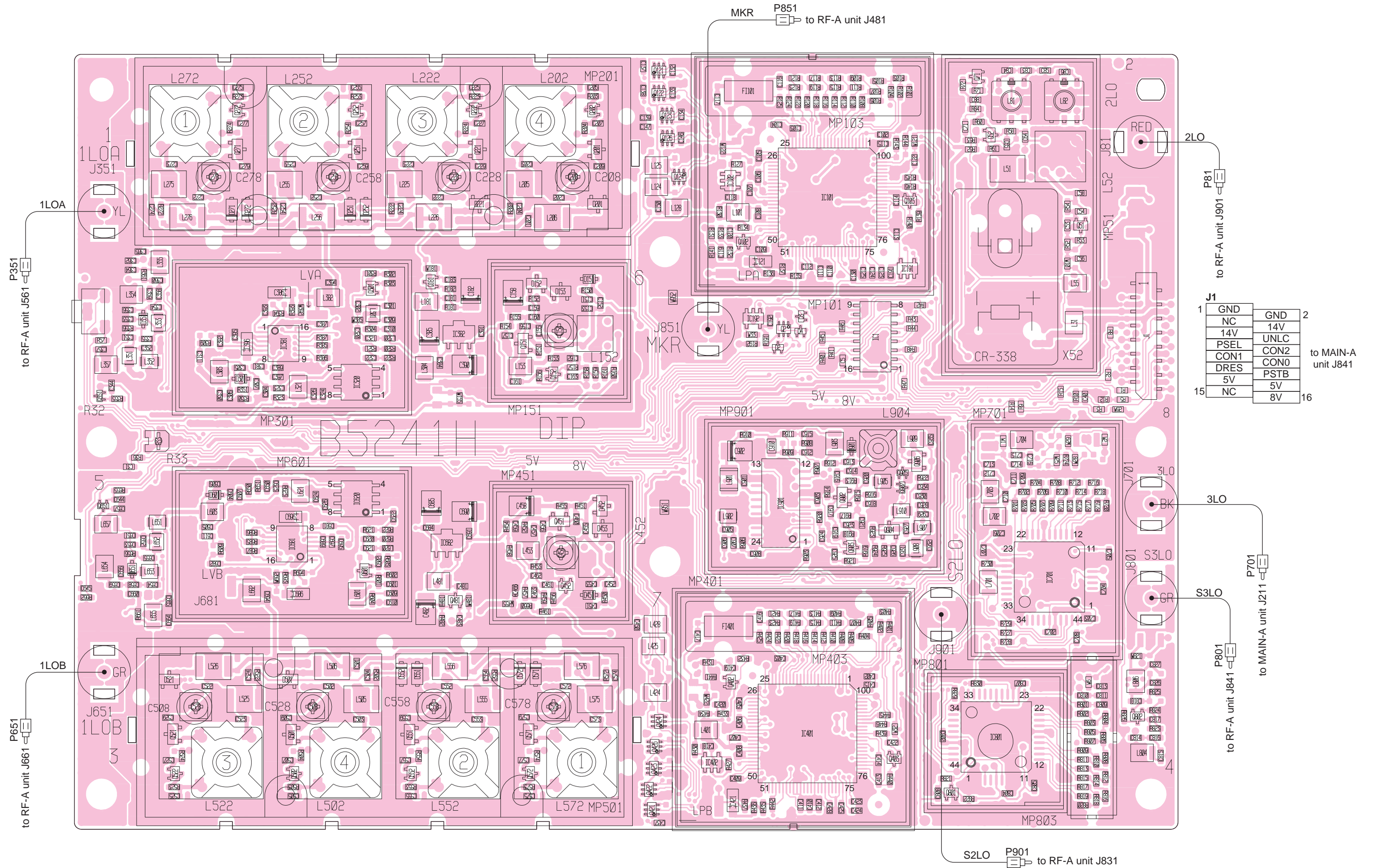

• PLL UNIT (BOTTOM VIEW)

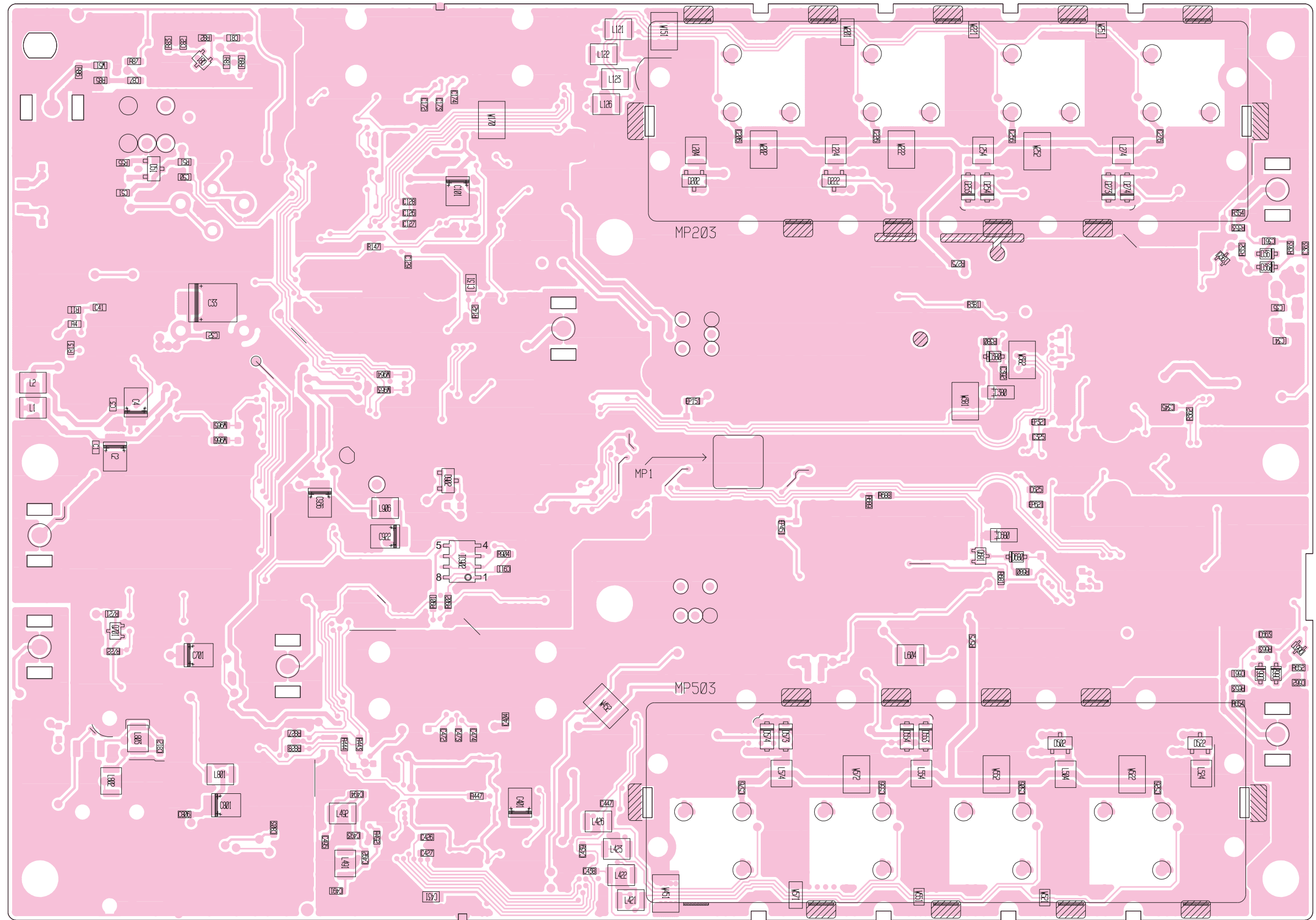

⊗ Soldering point

8-7 DSP-A, MEMORY AND BPF BOARDS

• DSP-A BOARD (TOP VIEW)

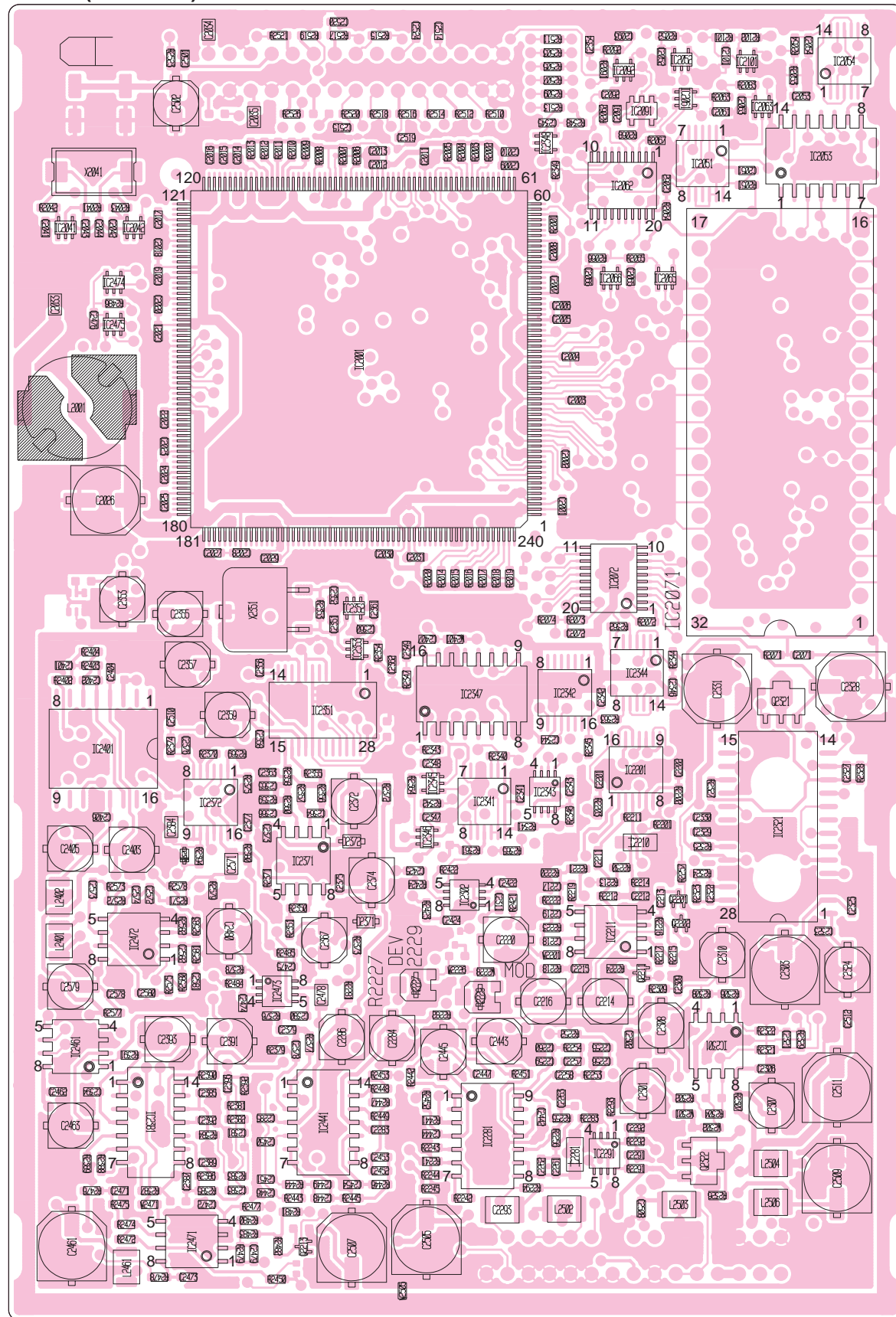

• MEMORY BOARD (TOP VIEW)

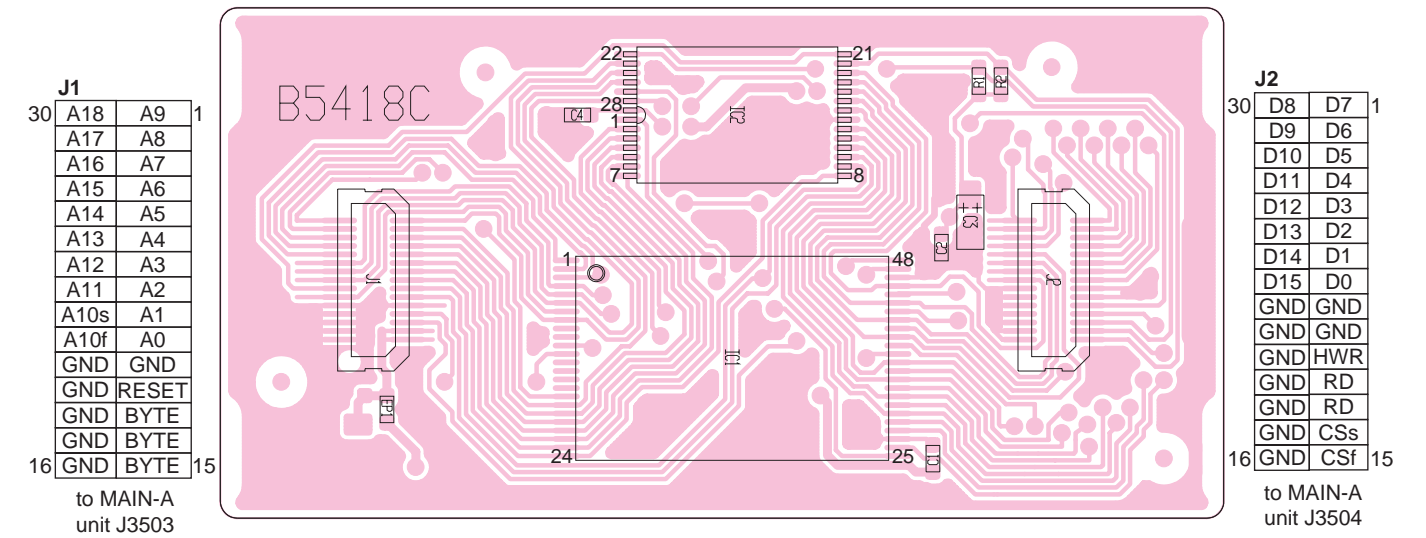

• BPF BOARD (TOP VIEW)



• MEMORY BOARD (BOTTOM VIEW)

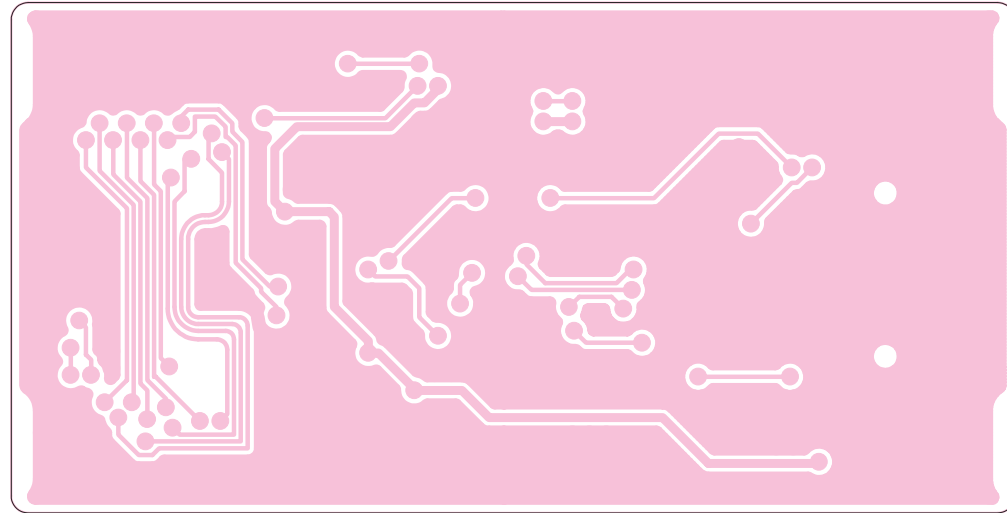

• DSP-A BOARD (BOTTOM VIEW)

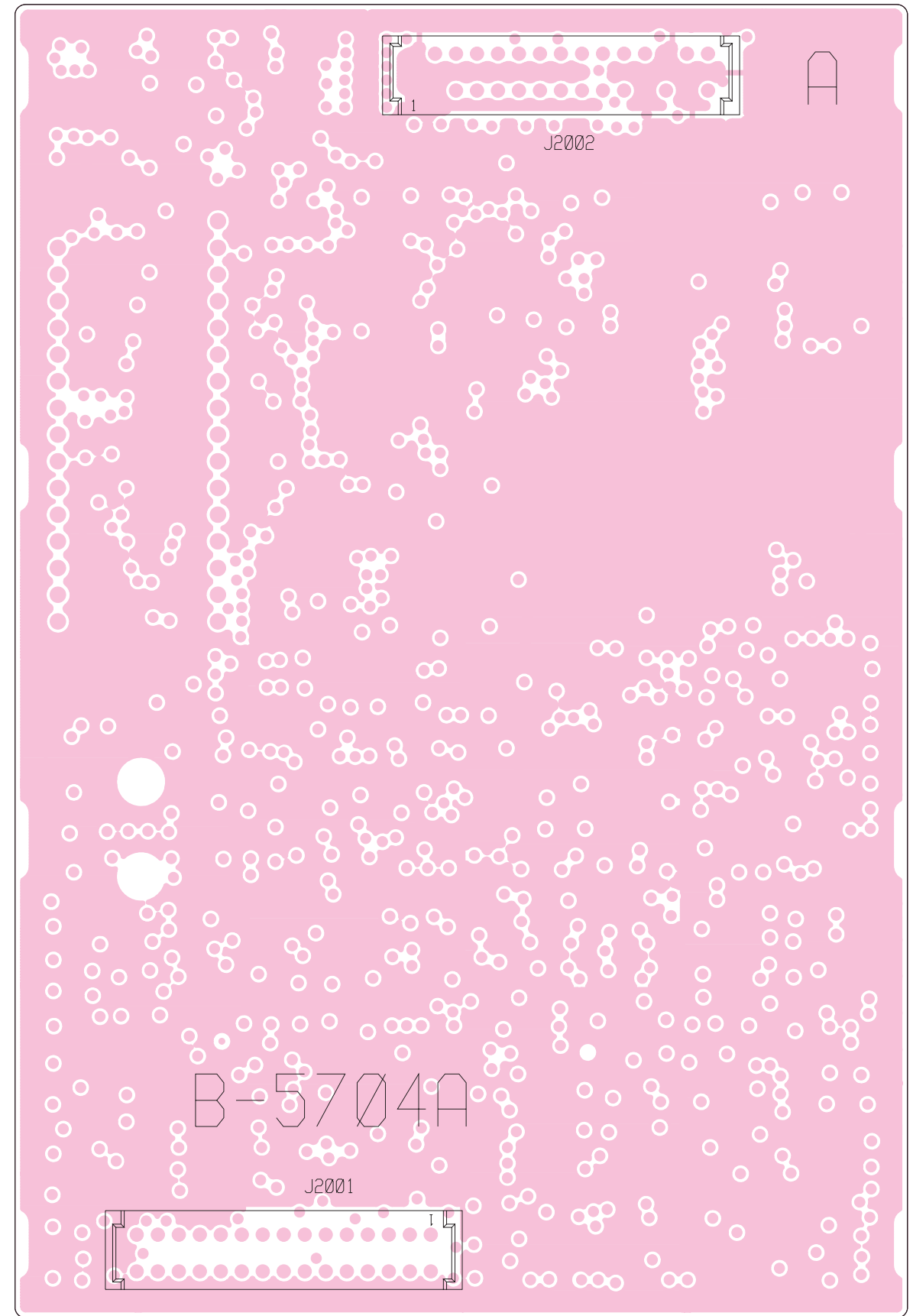

• BPF BOARD (BOTTOM VIEW)

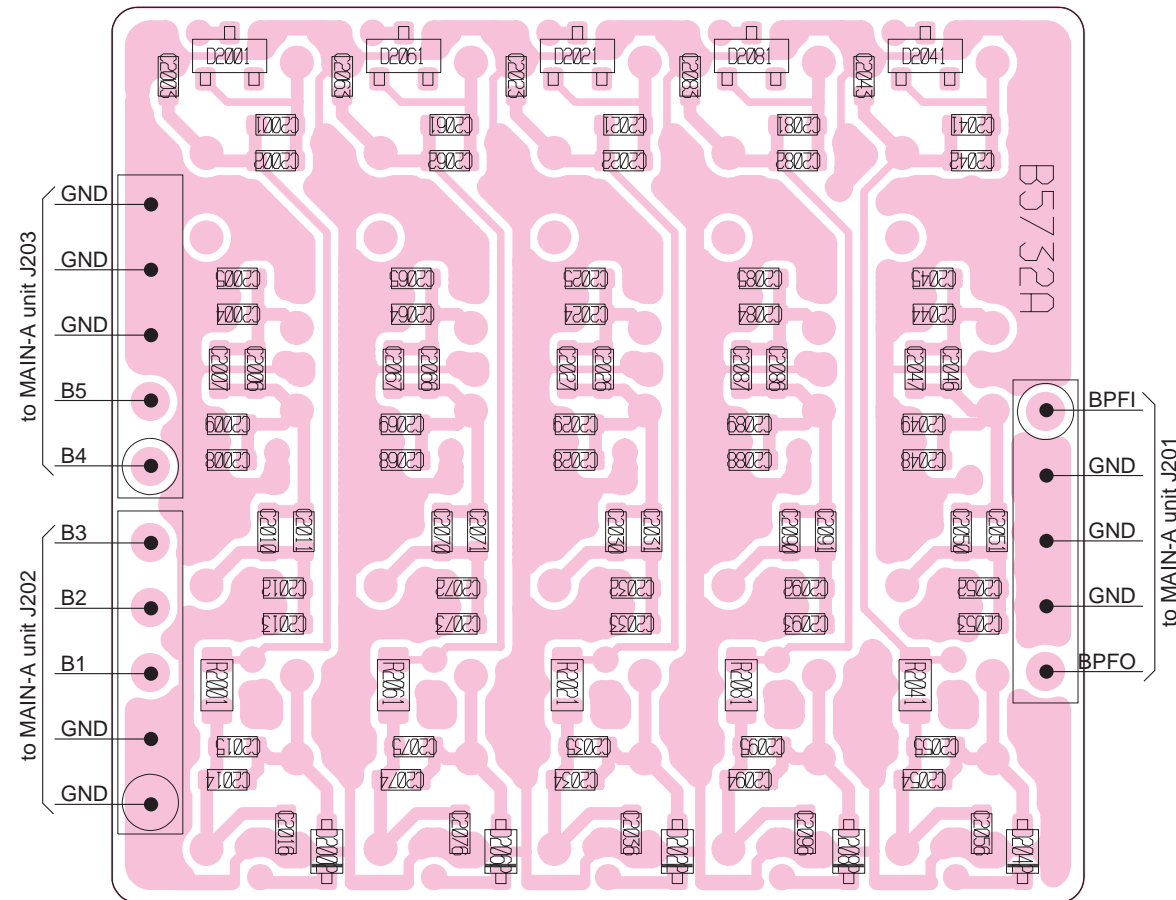

29	GND	1
8V	FMTL	GND
8V	GND	-5V
-5V	GND	-8V
-8V	GND	-8V
GND	DRAF	GND
GND	DTAF	GND
GND	GND	GND
GND	DMAF	GND
GND	D5VA	GND
GND	D5VA	GND
GND	D5VA	DTIF
DTIF	DRIF	GND
GND	GND	2
30		

to MAIN-A unit J201

2	GND	29
GND	DSKY	MSL1
RTDT	MSL1	TXS
CTFL	AMS	DSFR
MDAT	DSRS	DSFW
ACKS	MCK	CALS
NC	FMNS	NC
MODS	NC	MODES
DSDR	DPGI	GND
NSQO	GND	M5V_d
GND	NSQO	GND
M5V_d	GND	3R3V_d
GND	3R3V_d	AGRS
AGRS	3R3V_d	30
1		

to MAIN-A unit J202

• PA UNIT (BOTTOM VIEW)

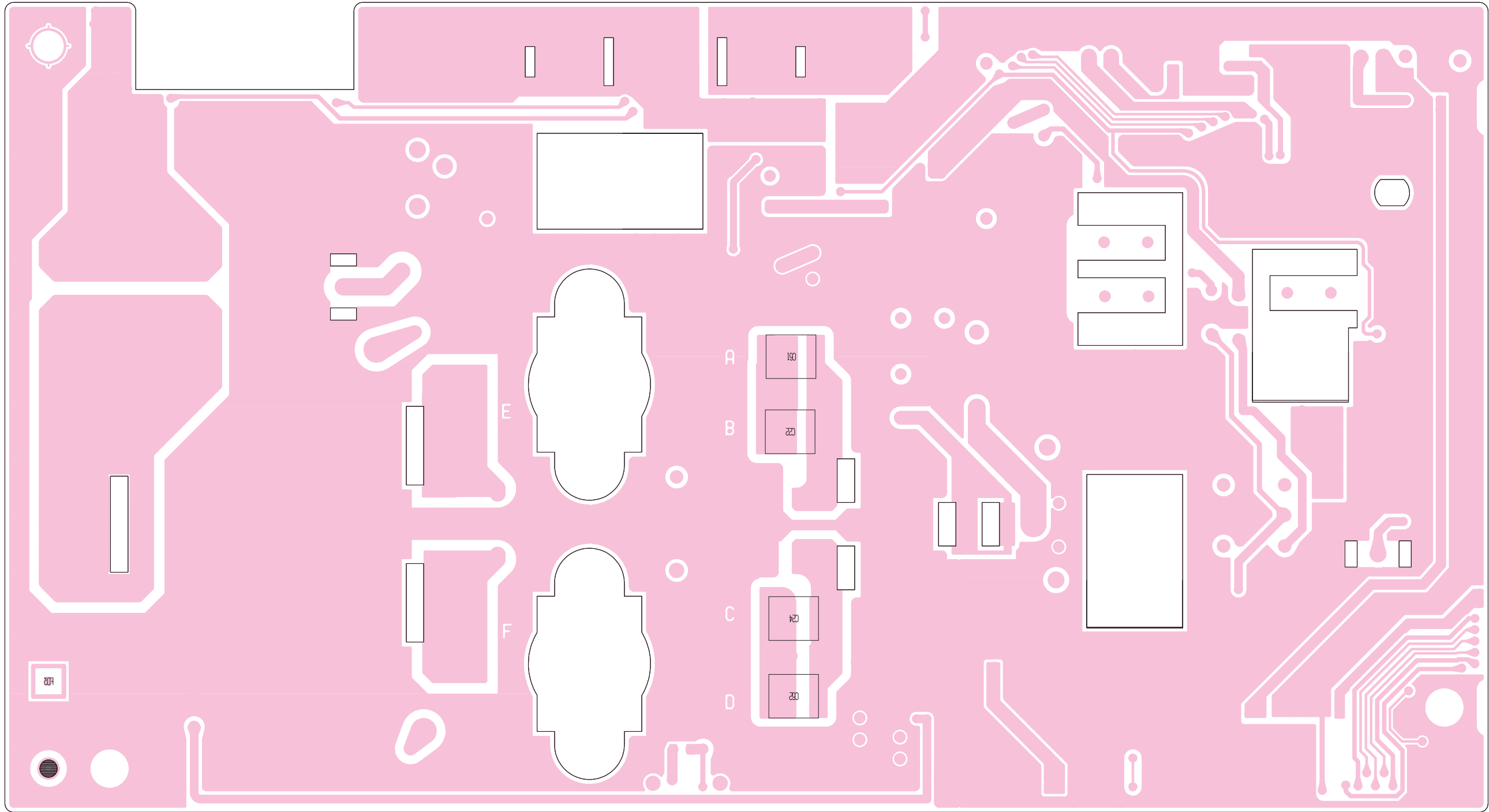

8-9 FILTER UNIT (TOP VIEW)

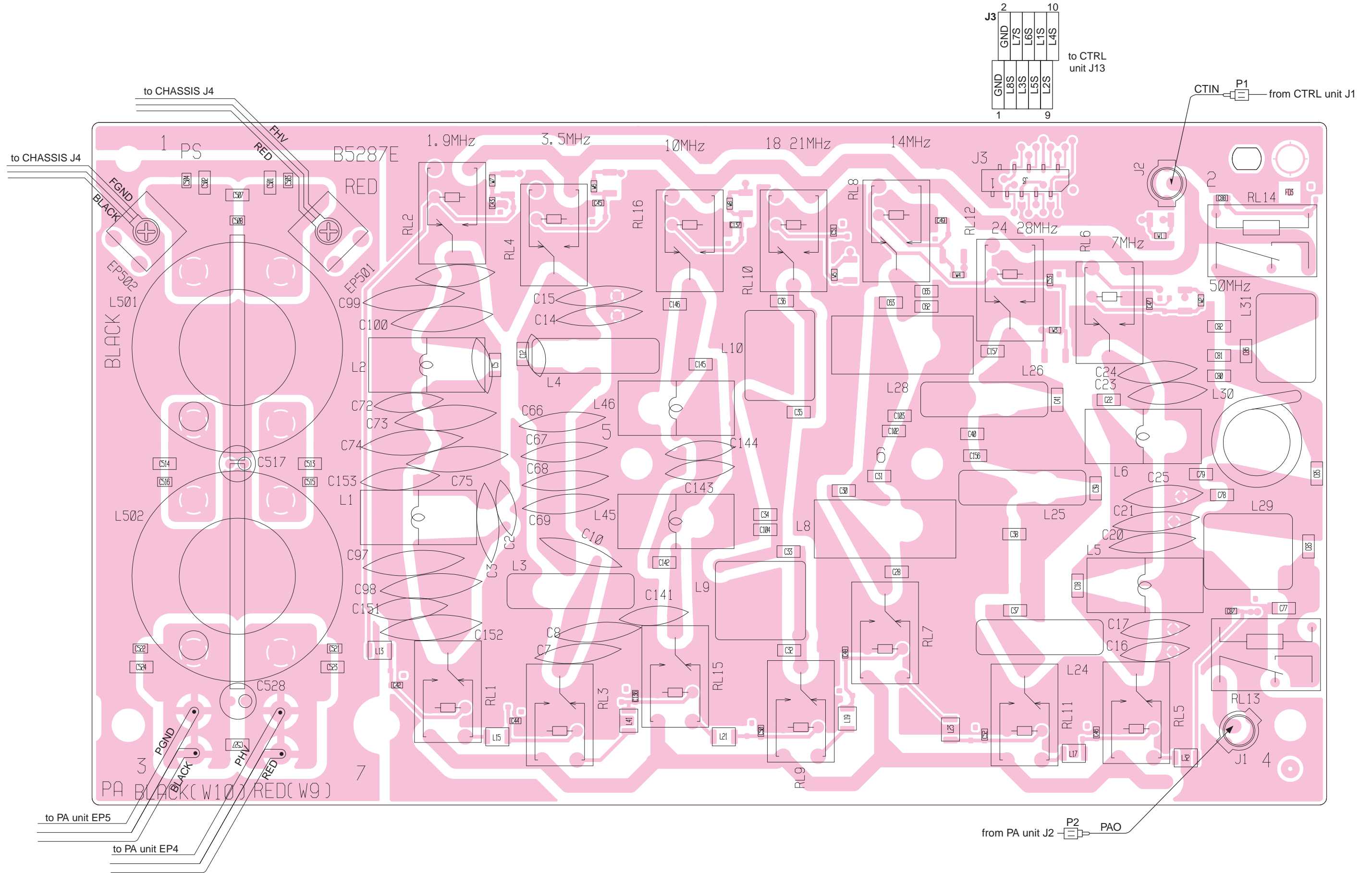

• FILTER UNIT (BOTTOM VIEW)

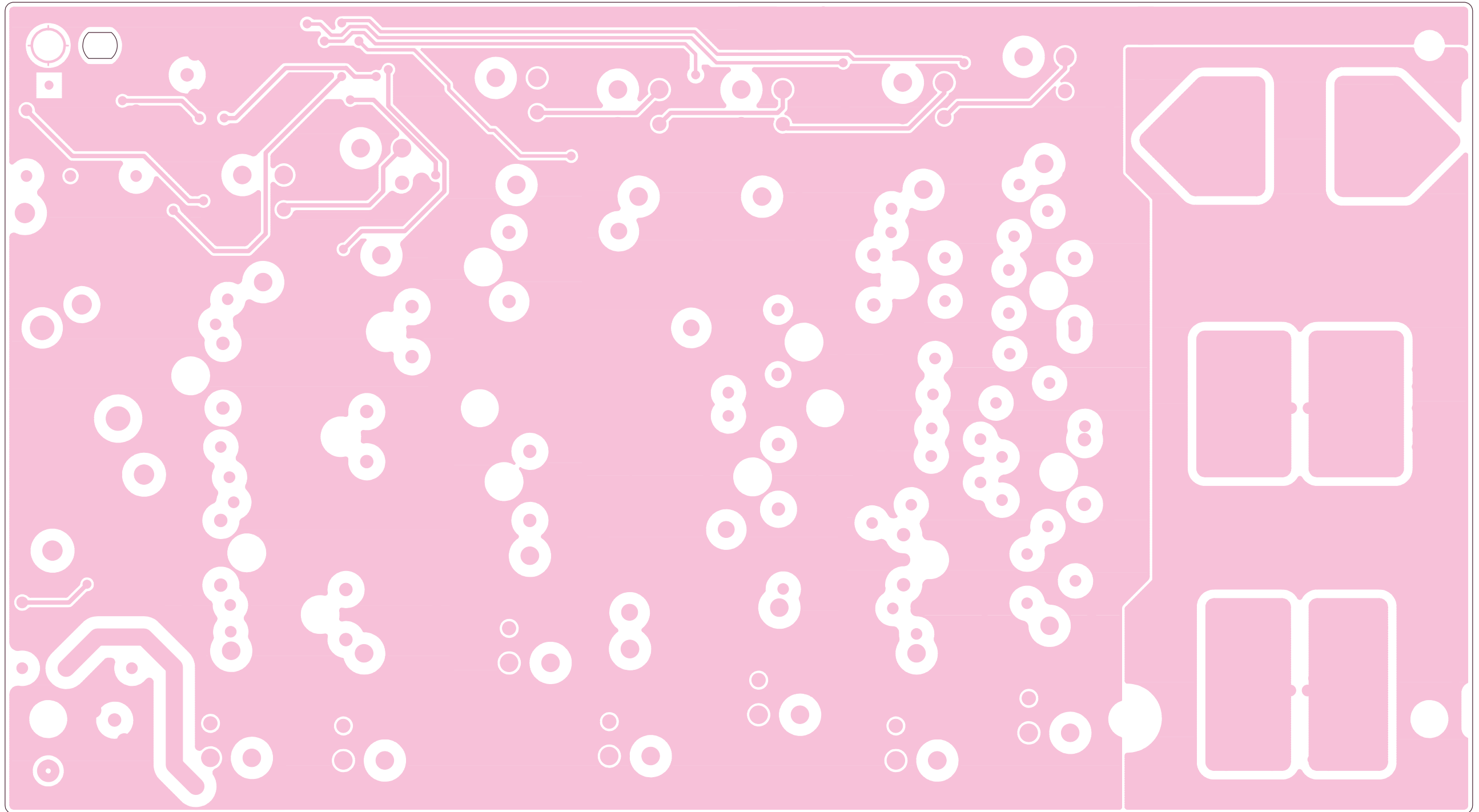

8-10 TUNER BOARD (TOP VIEW)

21	to CTRL unit J8										1
J5	GND	7M	14M	24M	GND	14V	CO3	CO1	CI3	CI1	GND
22	GND	3.5M	10M	18M	VHF	NC	14V	CO2	NVHF	CI2	GND
											2

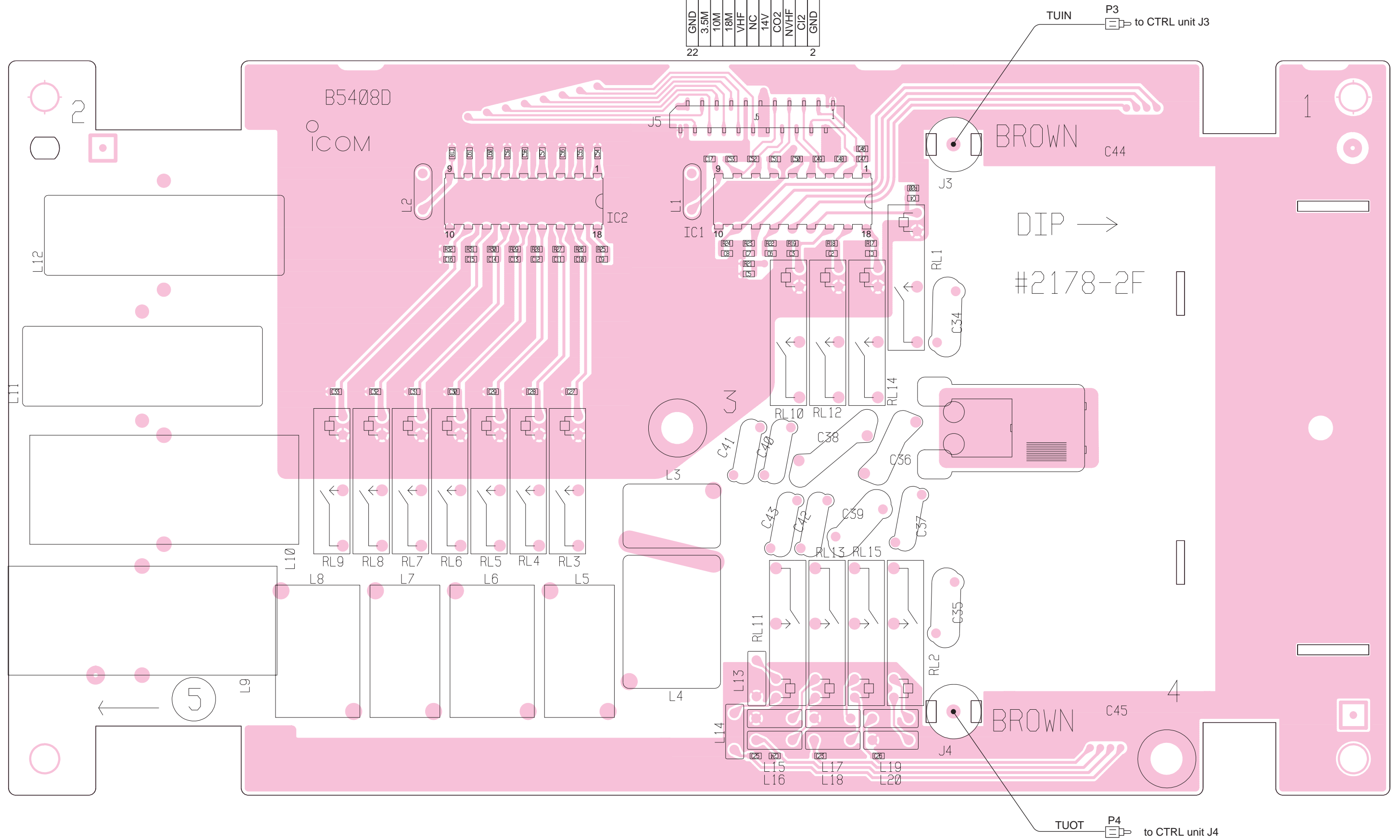

• TUNER BOARD (BOTTOM VIEW)

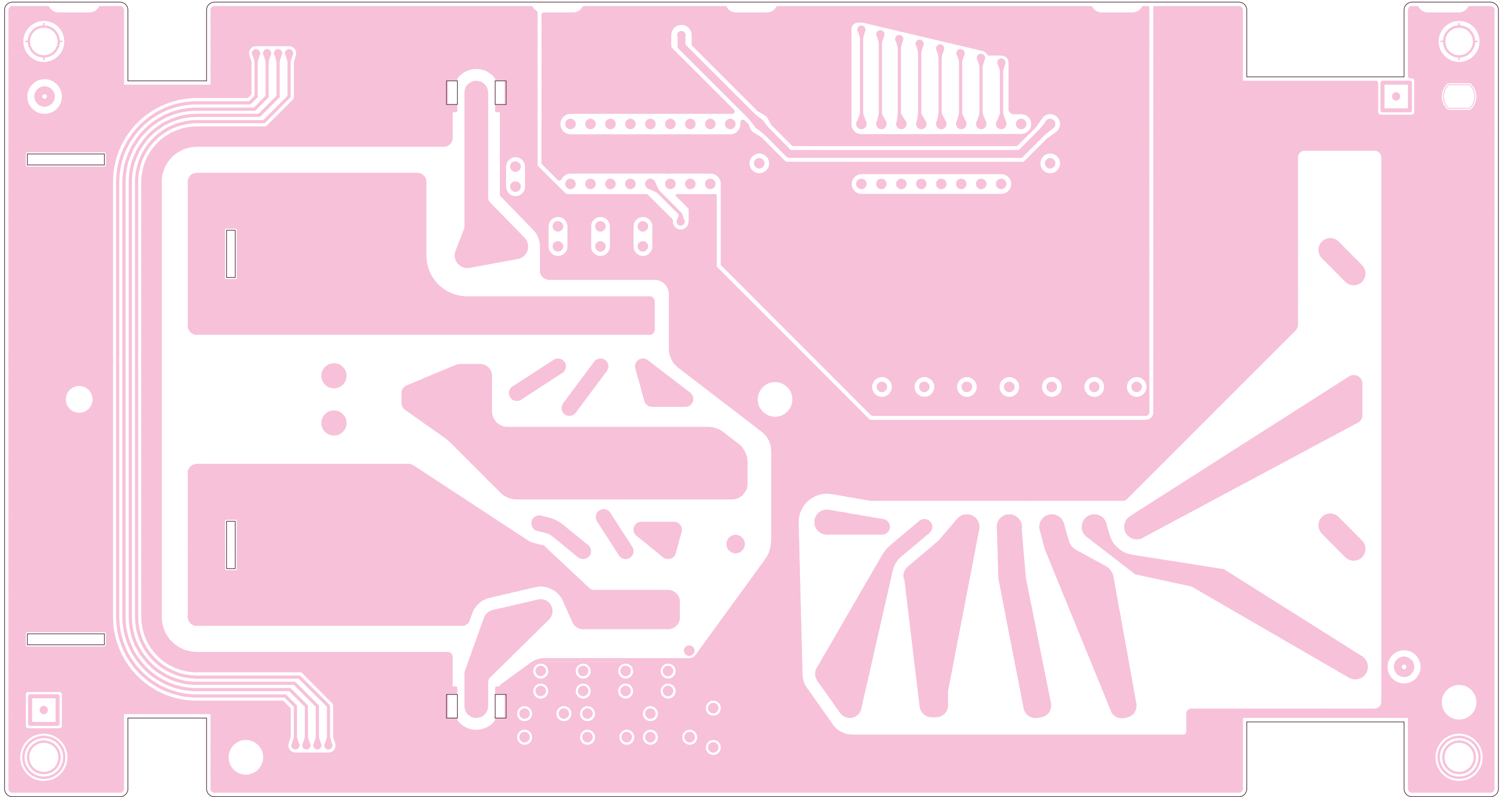

8-11 CTRL UNIT (TOP VIEW)

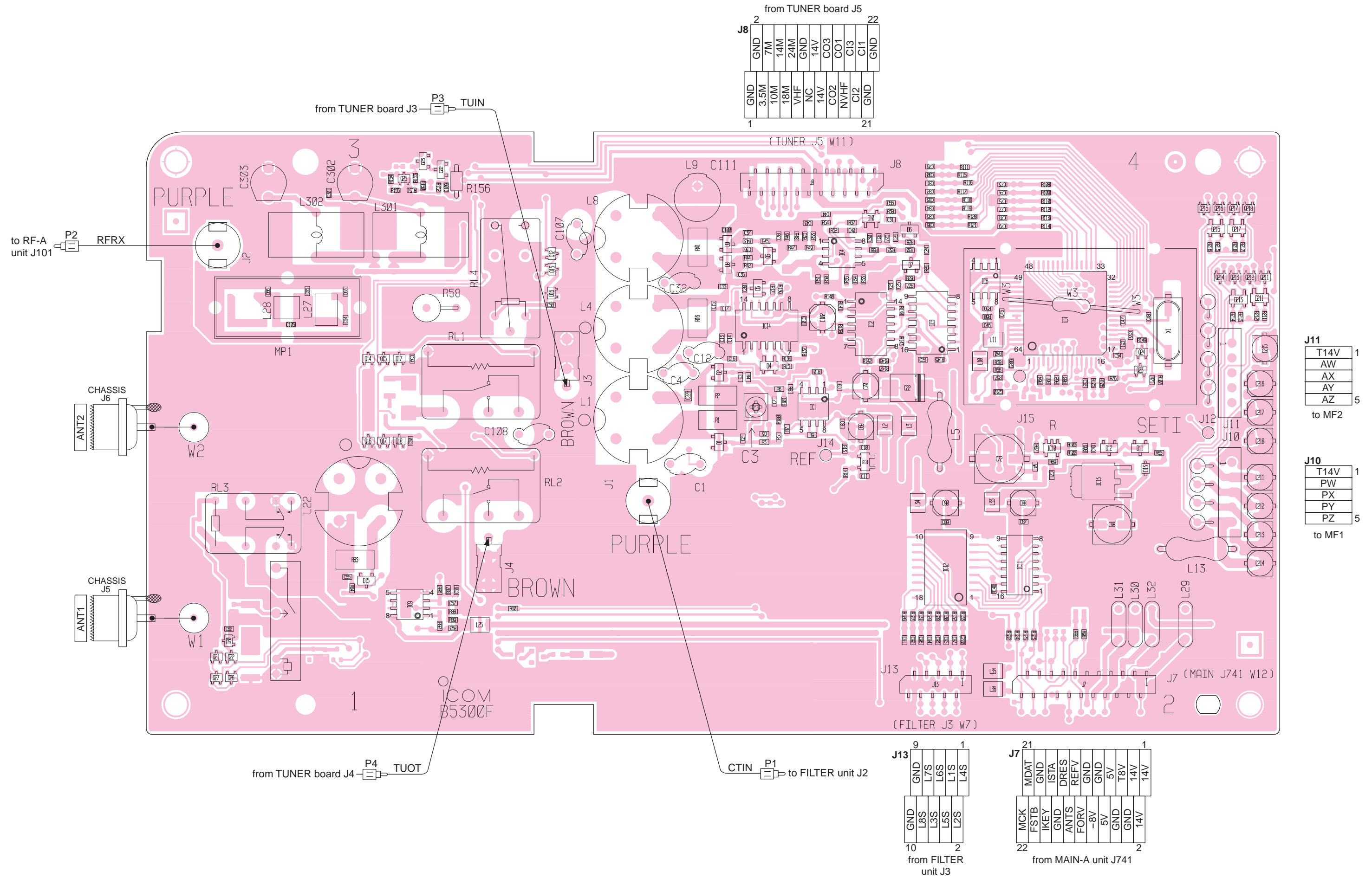

from TUNER board J5

2	GND	7M	14M	18M	VHF	NC	14V	CO3	CO1	CO13	C11	GND
1	GND	3.5M	10M	24M	VHF	NC	14V	CO2	NVHF	C12	GND	21

J11

T14V	1
AW	
AX	
AY	
AZ	5

to MF2

J10

T14V	1
PW	
PX	
PY	
PZ	5

to MF1

J13

9	GND	1
L7S	L6S	L4S
L3S	L1S	L2S
10		2

from FILTER unit J3

J7

21	MCK	1
FSTB	GND	
IKEY	ISTA	
GND	DRES	
ANTS	REFV	
FORV	GND	
-8V	GND	
5V	5V	
GND	T8V	
GND	14V	
14V	14V	
2		2

from MAIN-A unit J741

• CTRL UNIT (BOTTOM VIEW)

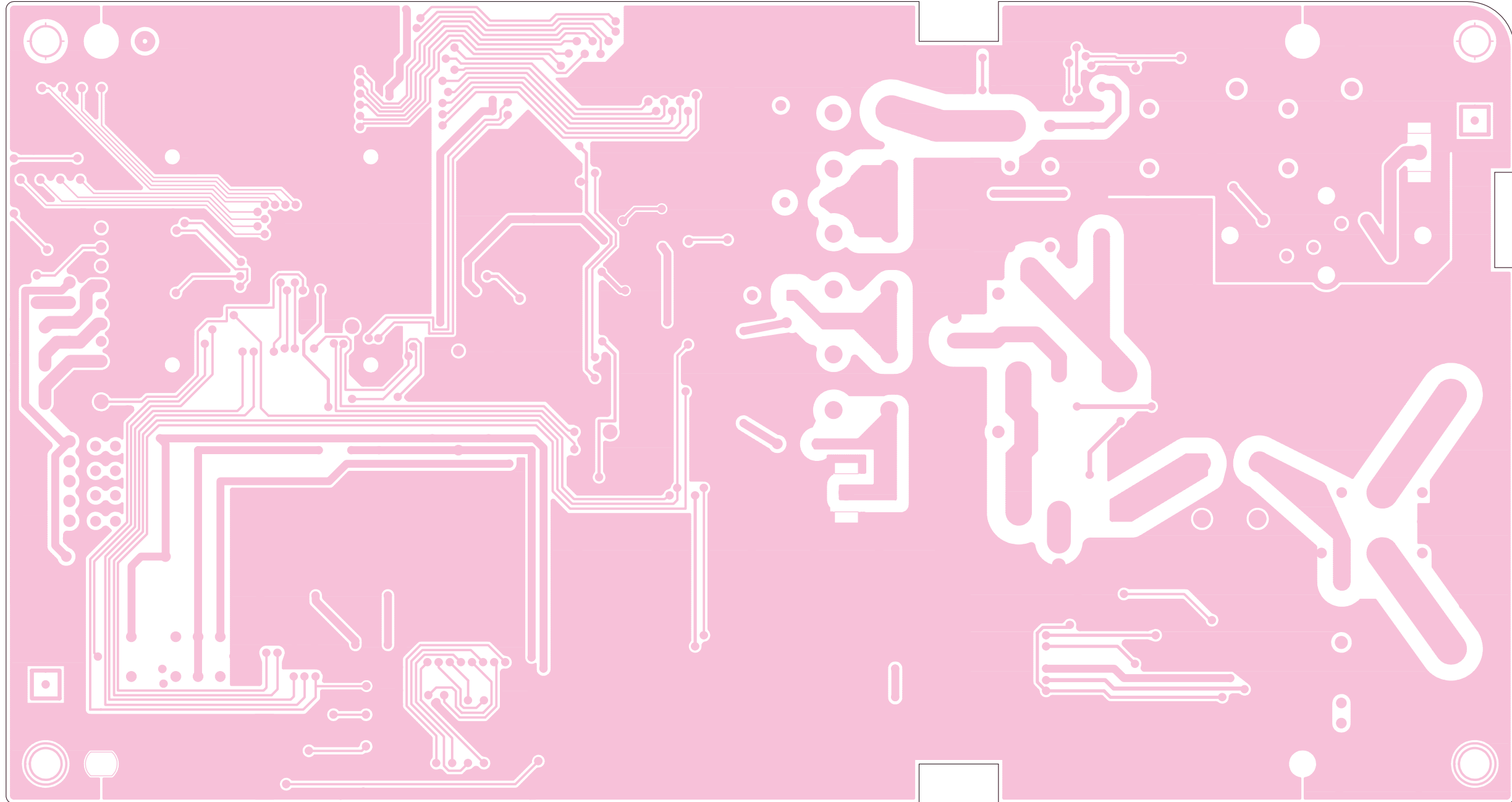

SECTION 9 BLOCK DIAGRAM

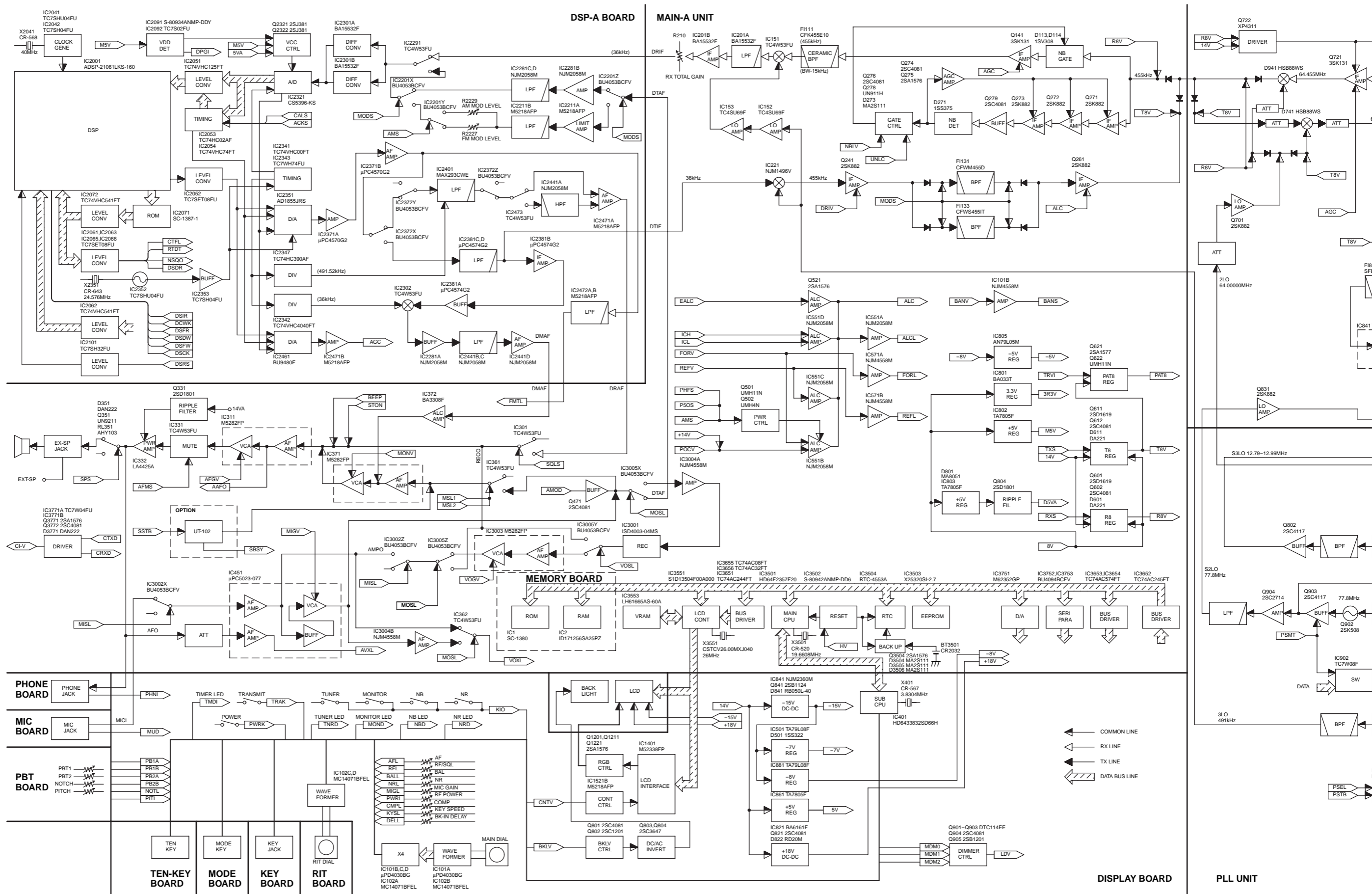

SECTION 10 VOLTAGE DIAGRAMS

10-1 FRONT UNIT

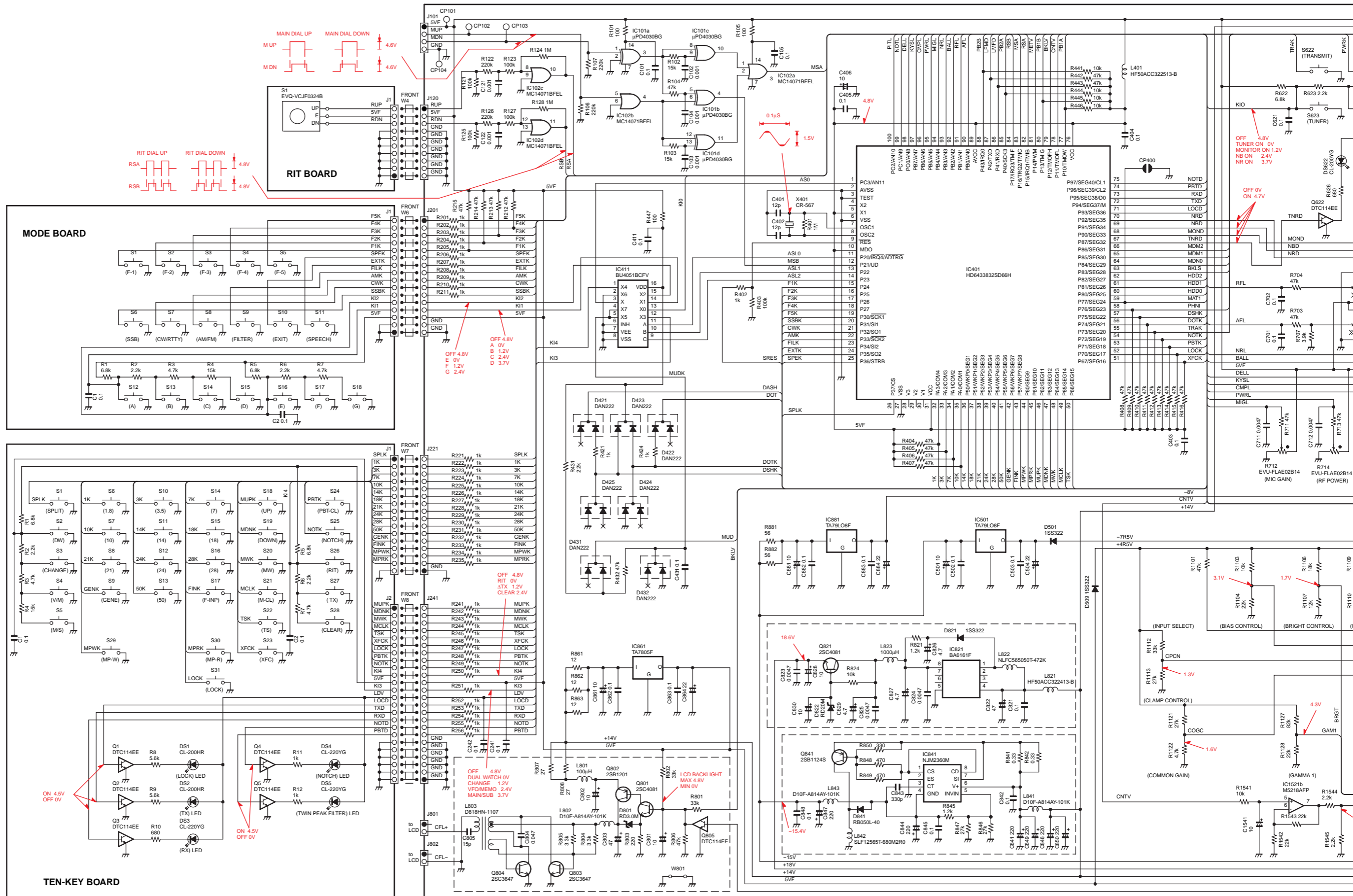

10-2 DSP-A BOARD

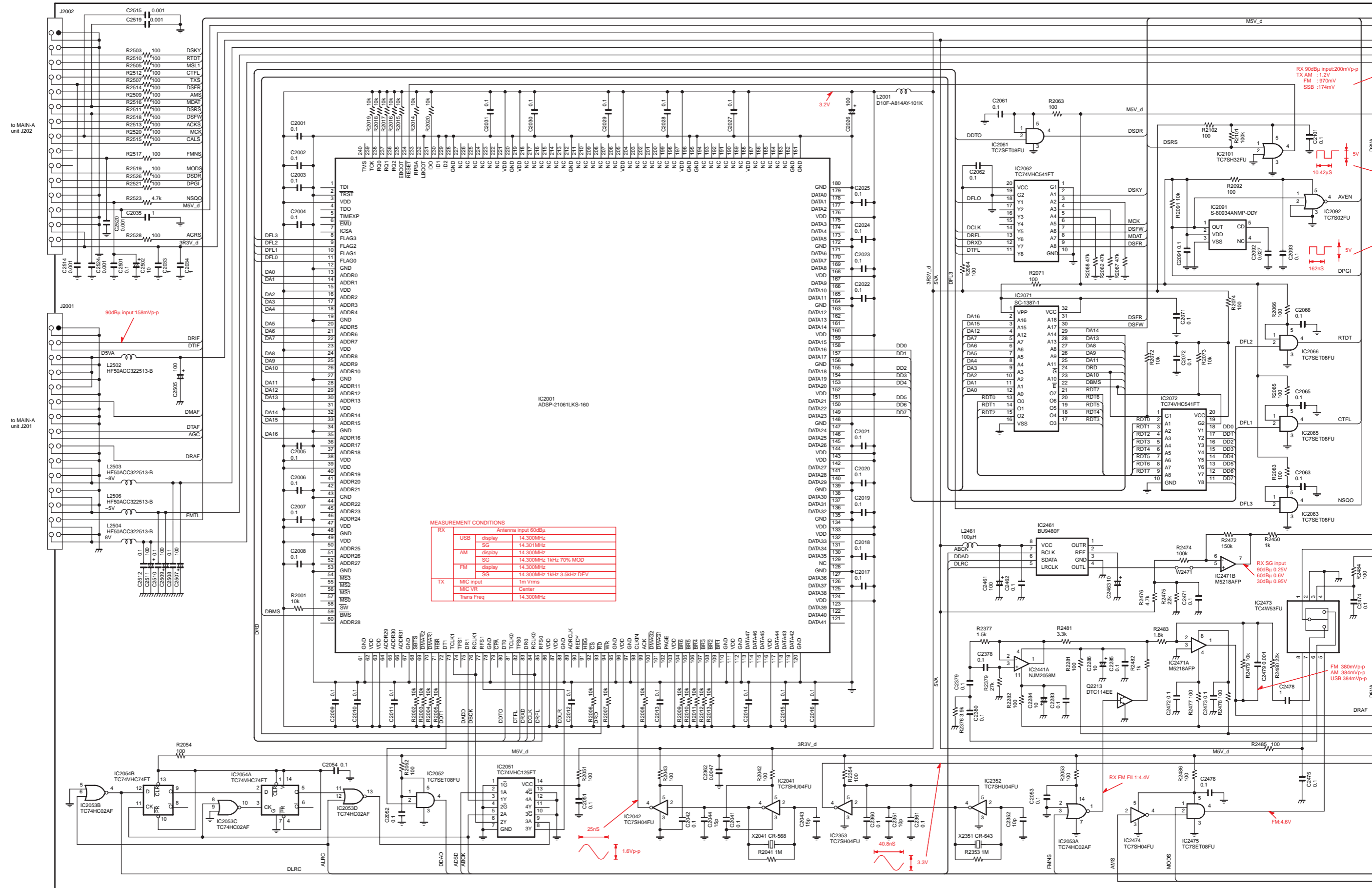

10-3 TUNER, MEMORY BOARDS AND CTRL UNIT

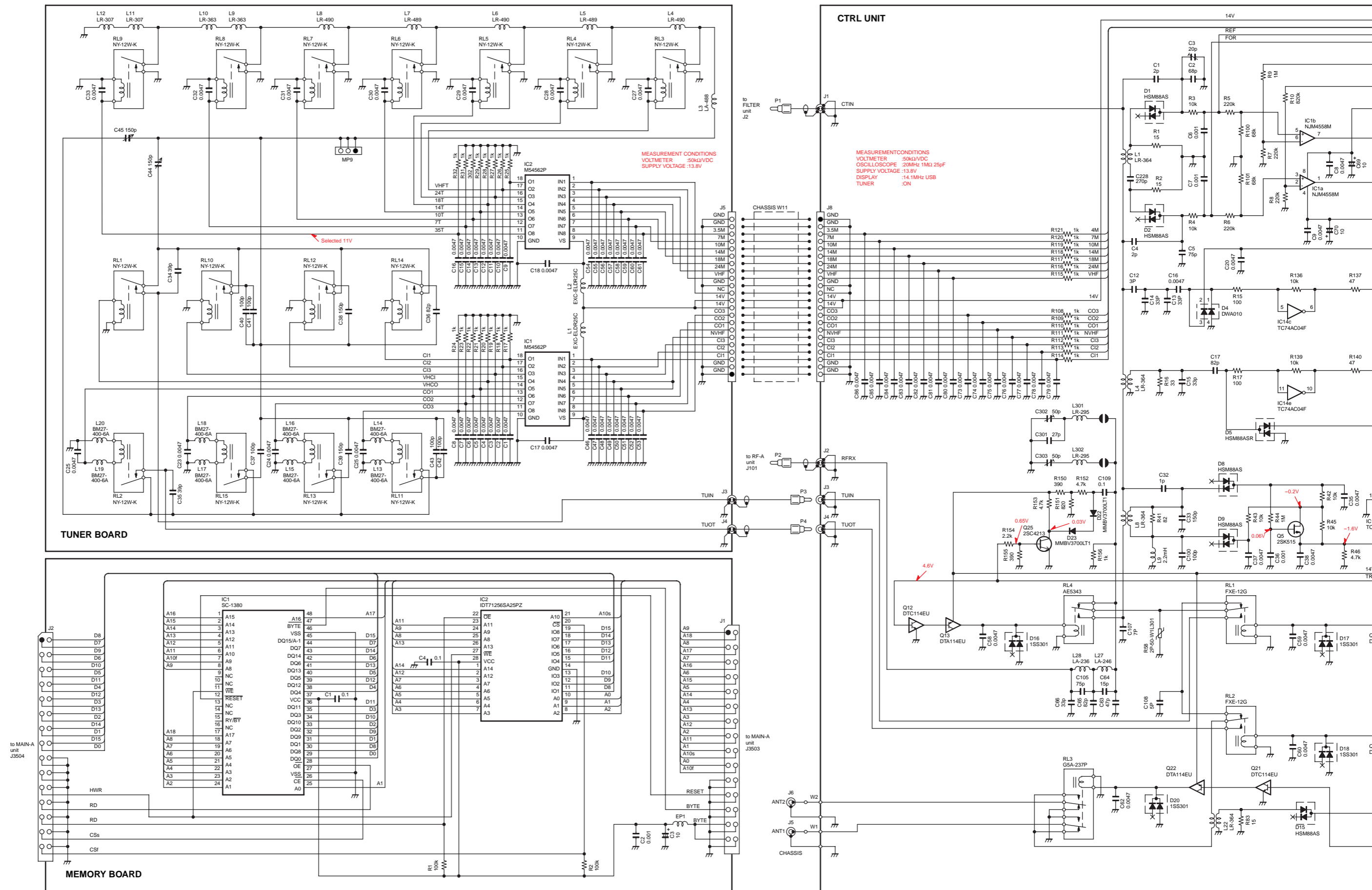

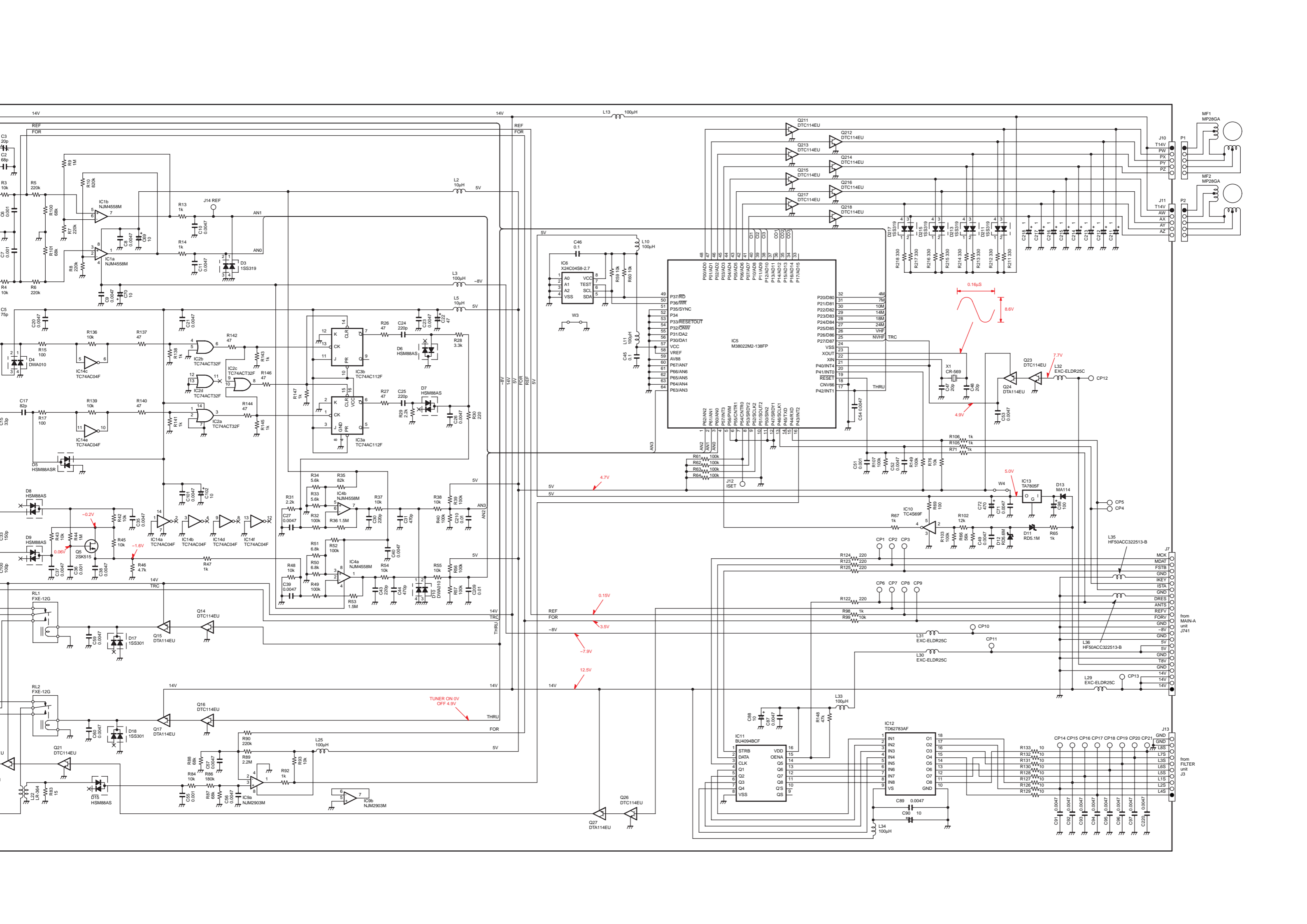

10-4 MAIN-A UNIT (1)

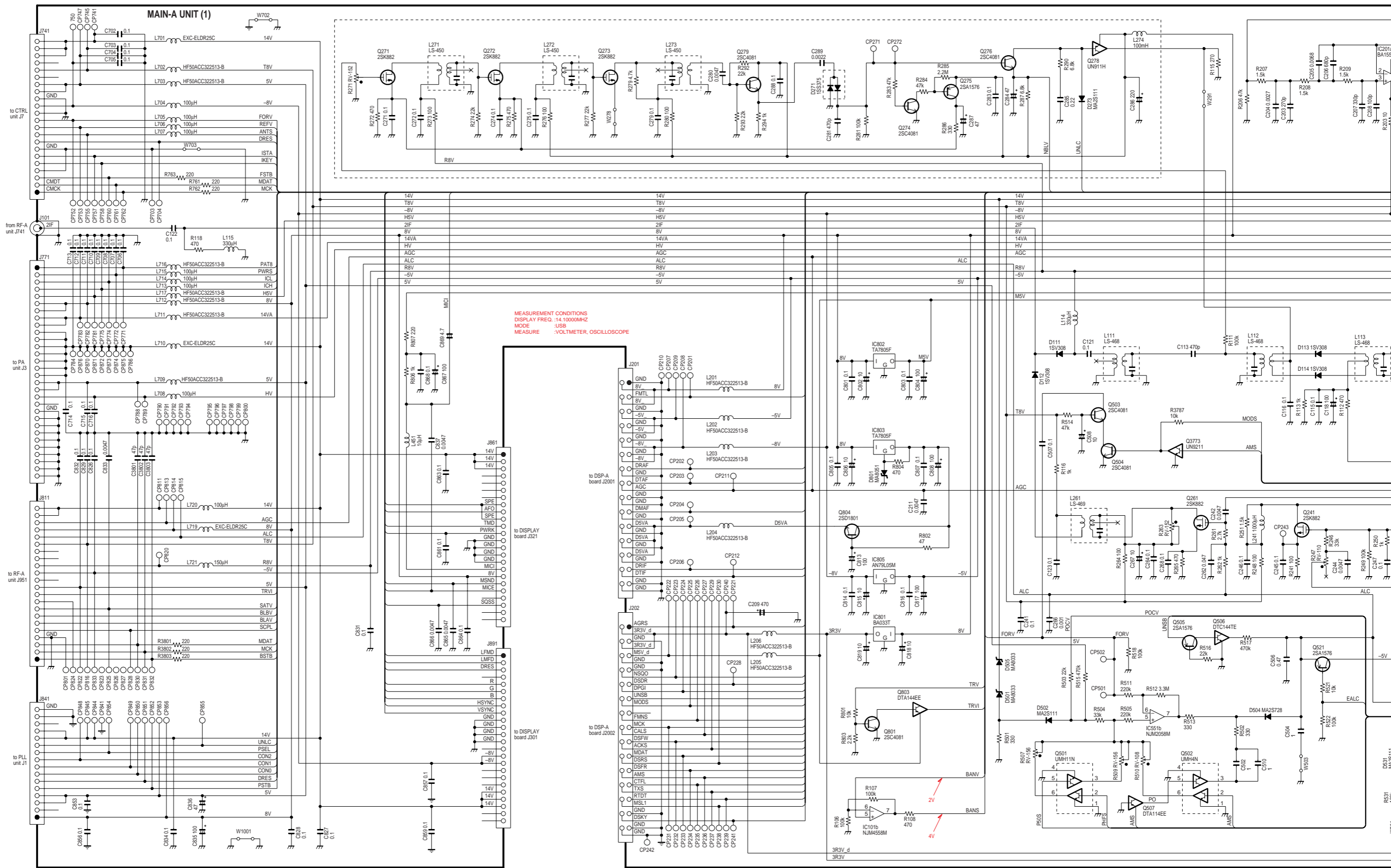

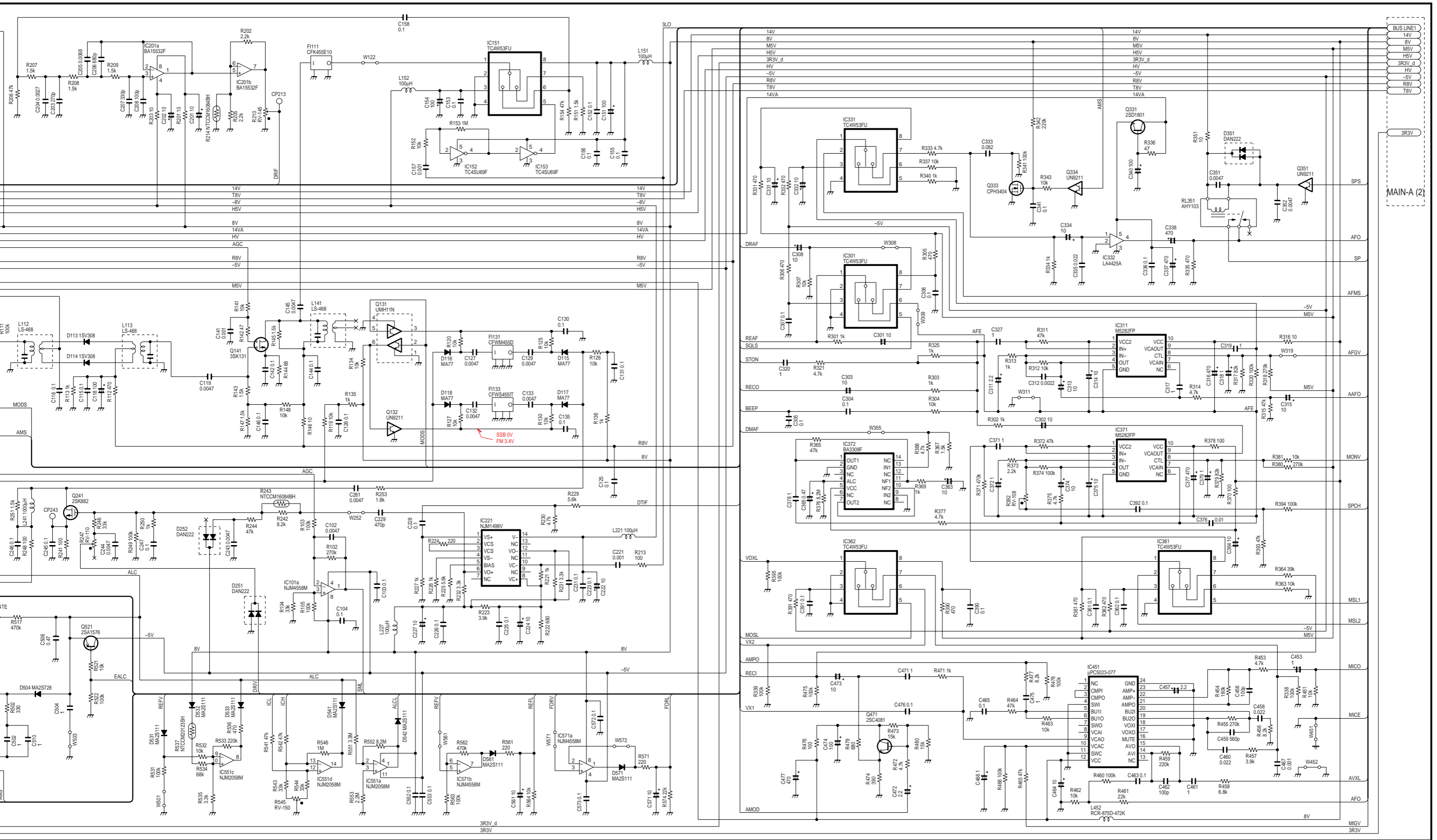

10-5 MAIN-A UNIT (2)

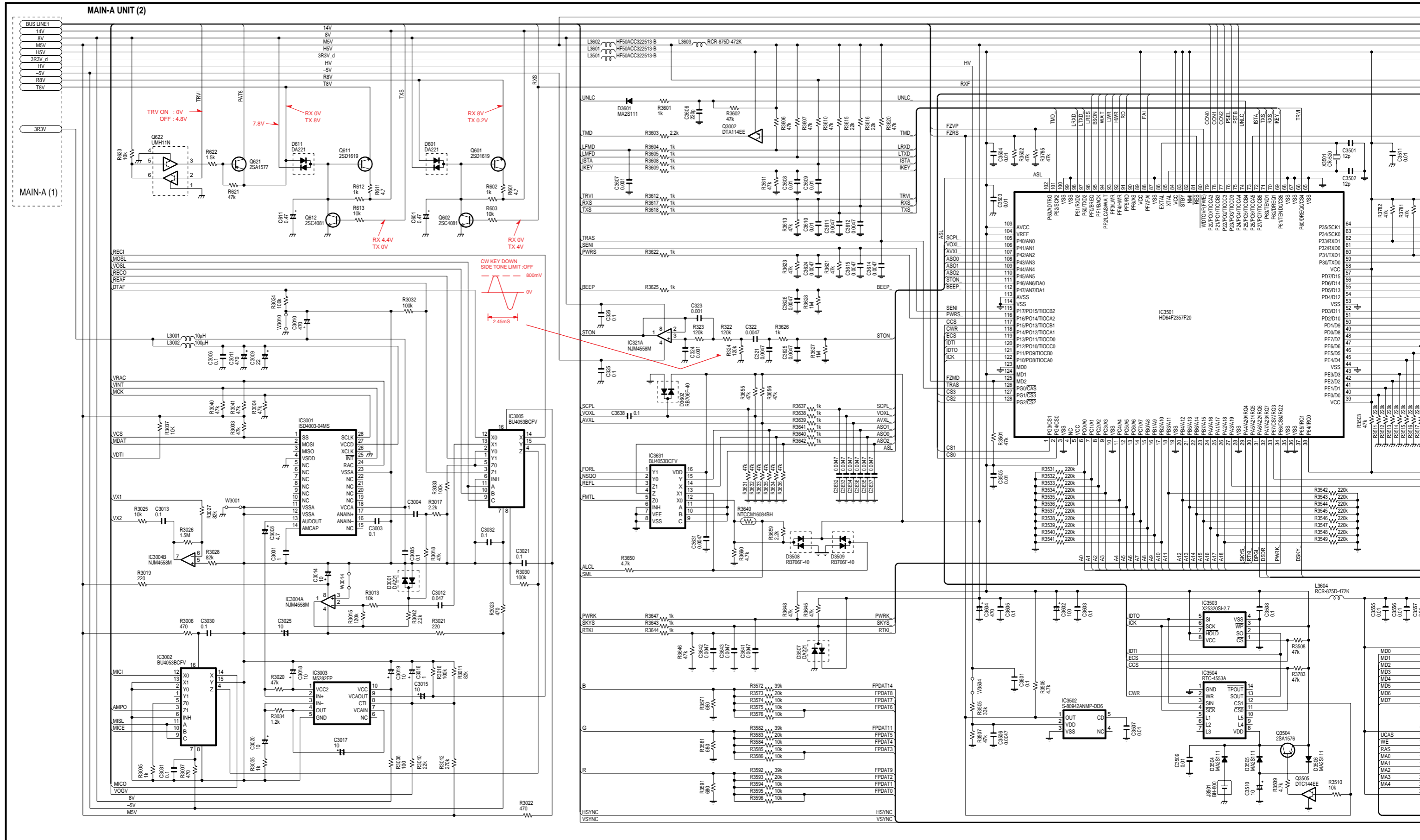

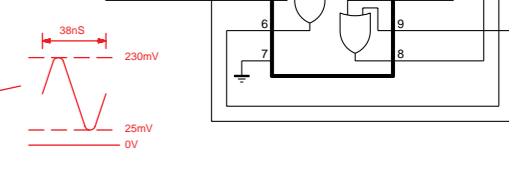
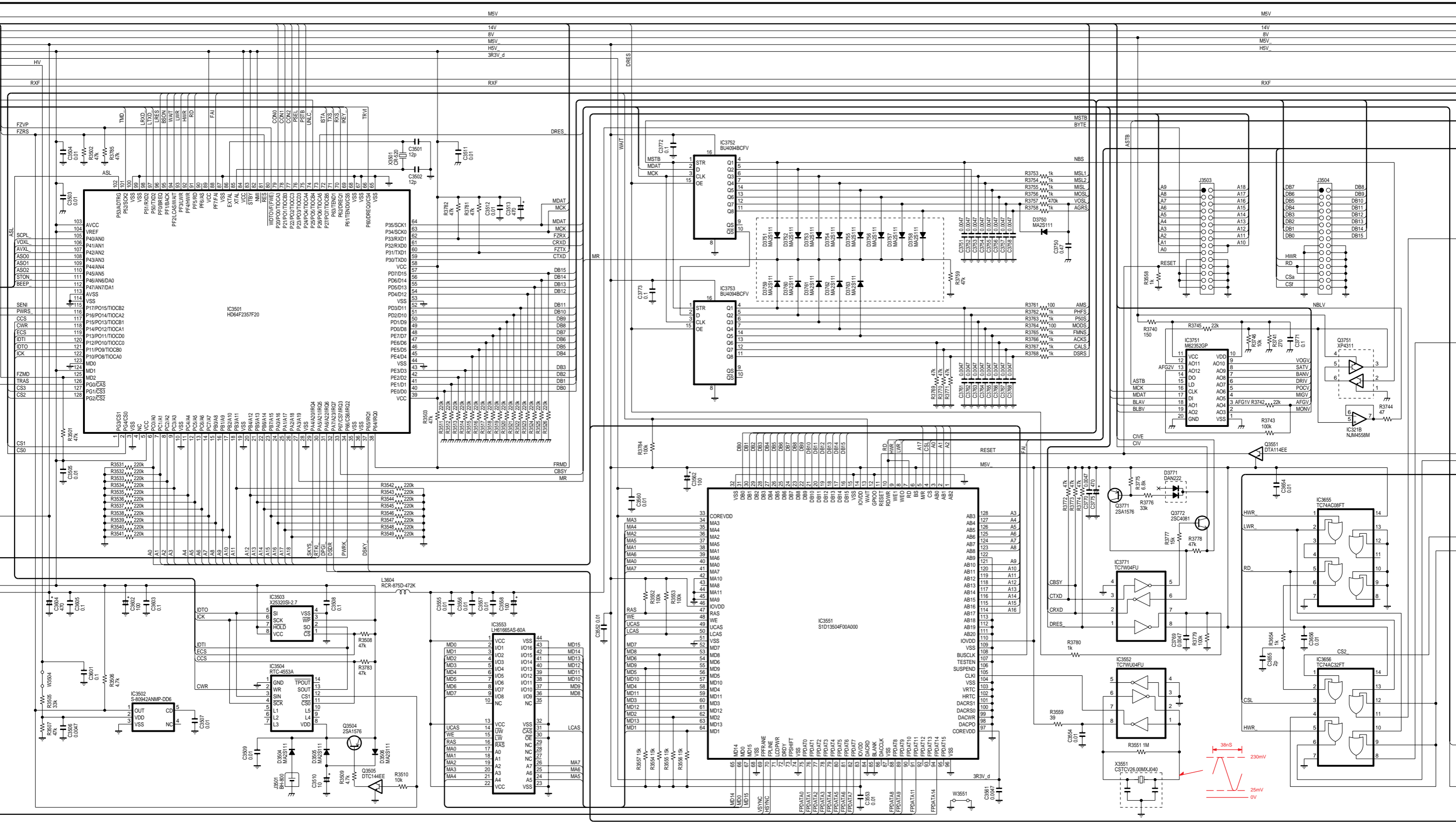

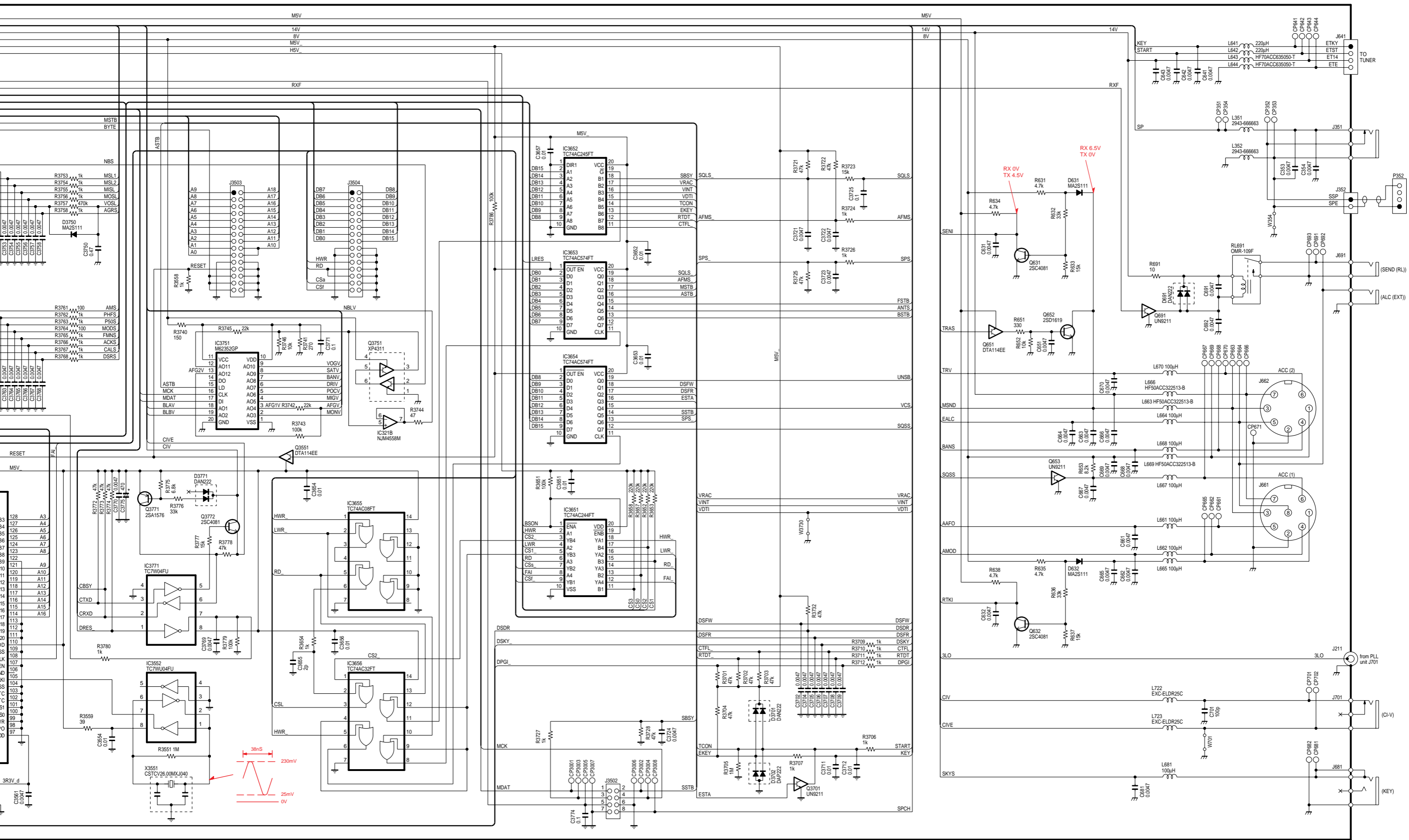

10-6 PLL UNIT

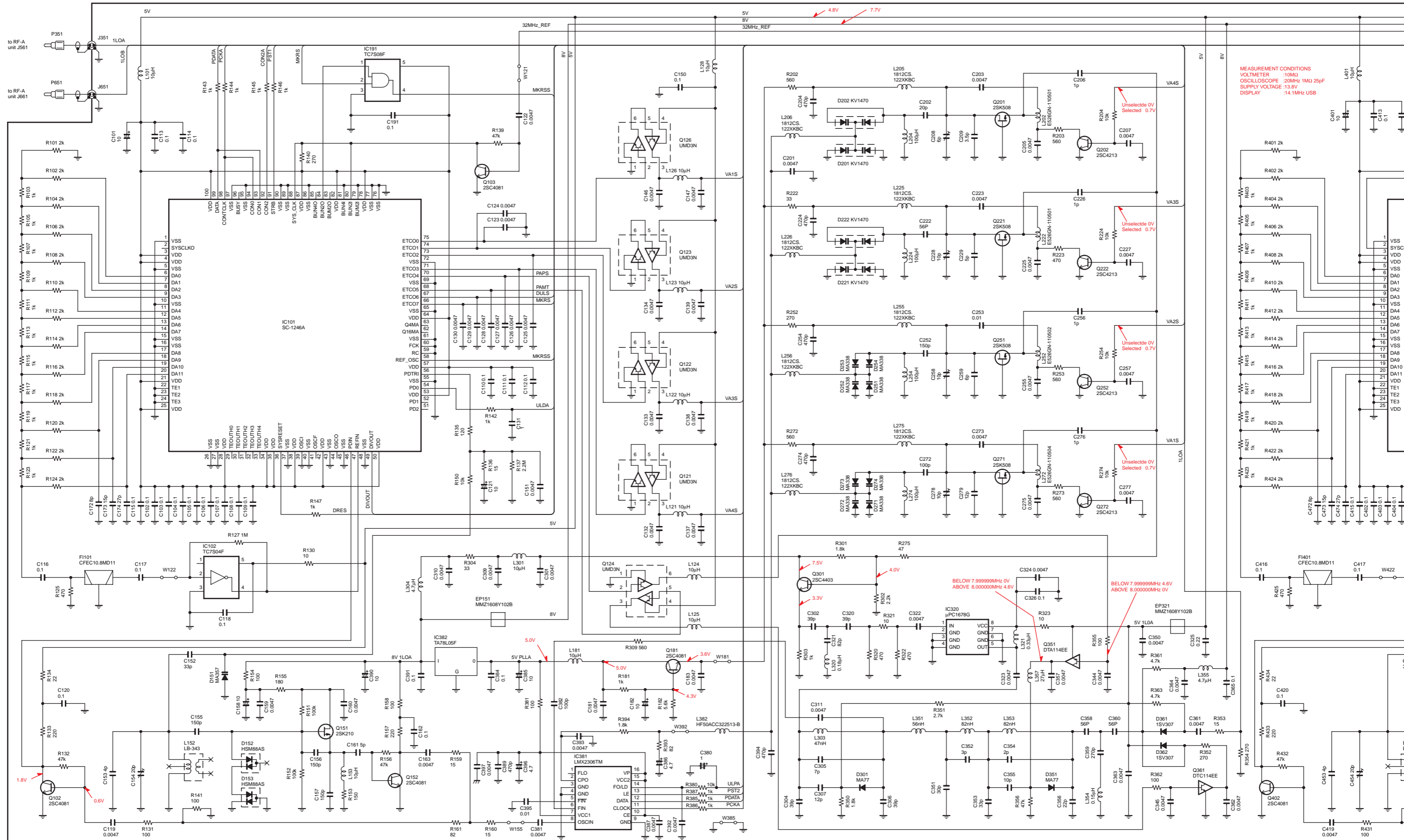

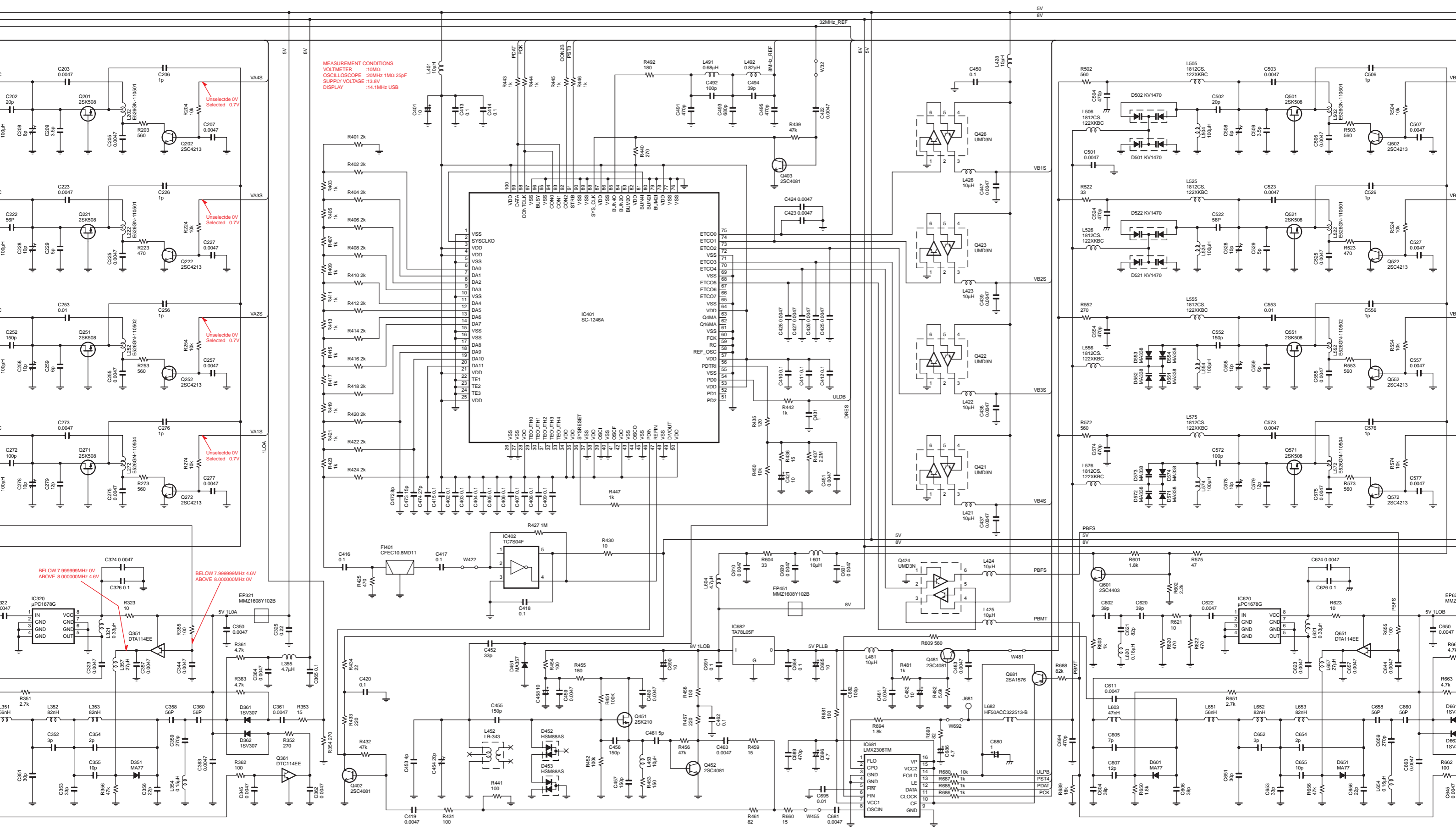

MEASUREMENT CONDITIONS
VOLTMETER :10M Ω
OSCILLOSCOPE :20MHz 1M Ω 25pF
SUPPLY VOLTAGE :13.8V
DISPLAY :14.1MHz USB

Unselecte 0V
Selected 0.7V

Unselecte 0V
Selected 0.7V

Unselecte 0V
Selected 0.7V

Unselecte 0V
Selected 0.7V

BELOW 7.999999MHz 0V
ABOVE 8.000000MHz 4.6V

BELOW 7.999999MHz 4.6V
ABOVE 8.000000MHz 0V

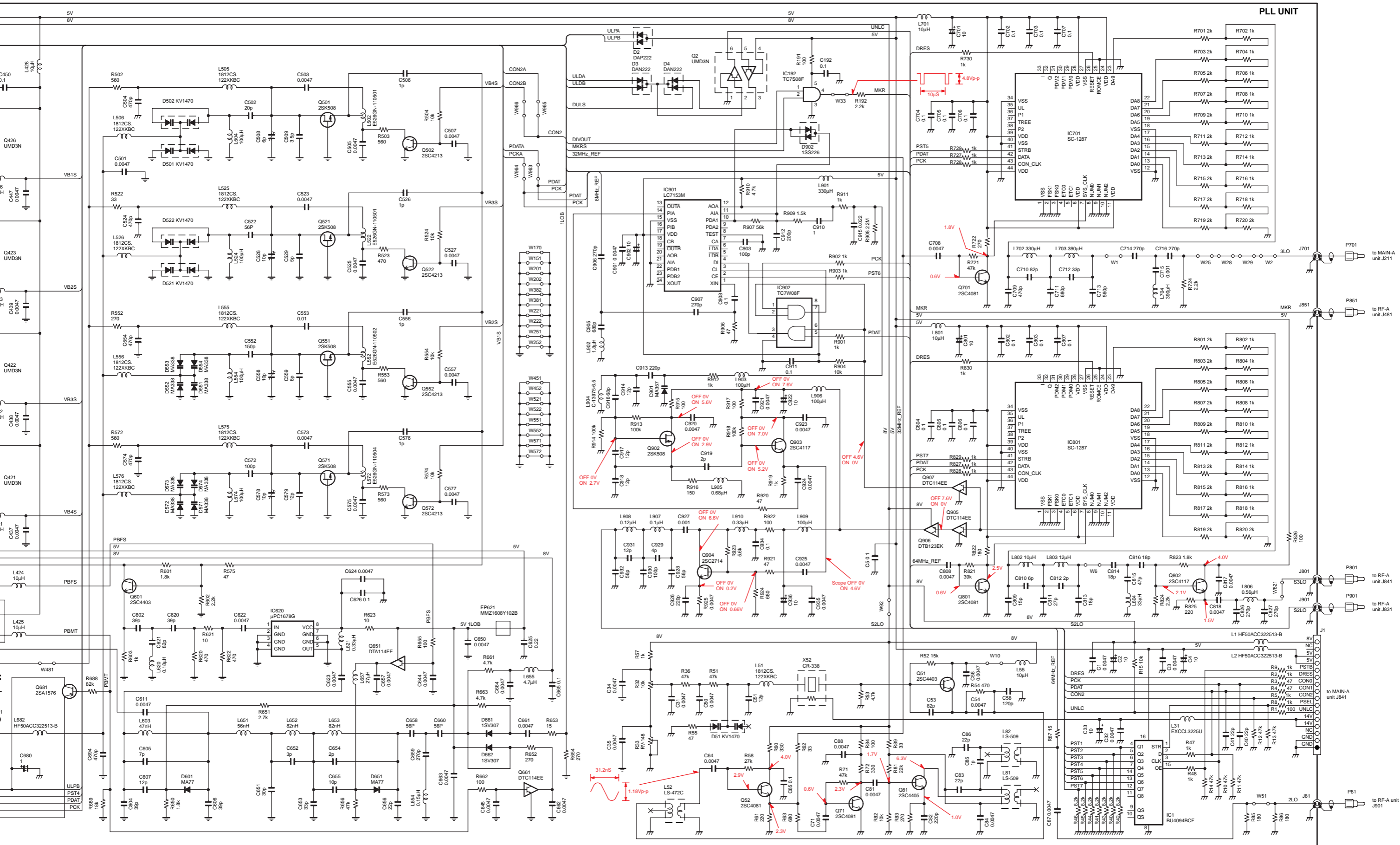

10-7 PA AND FILTER UNITS

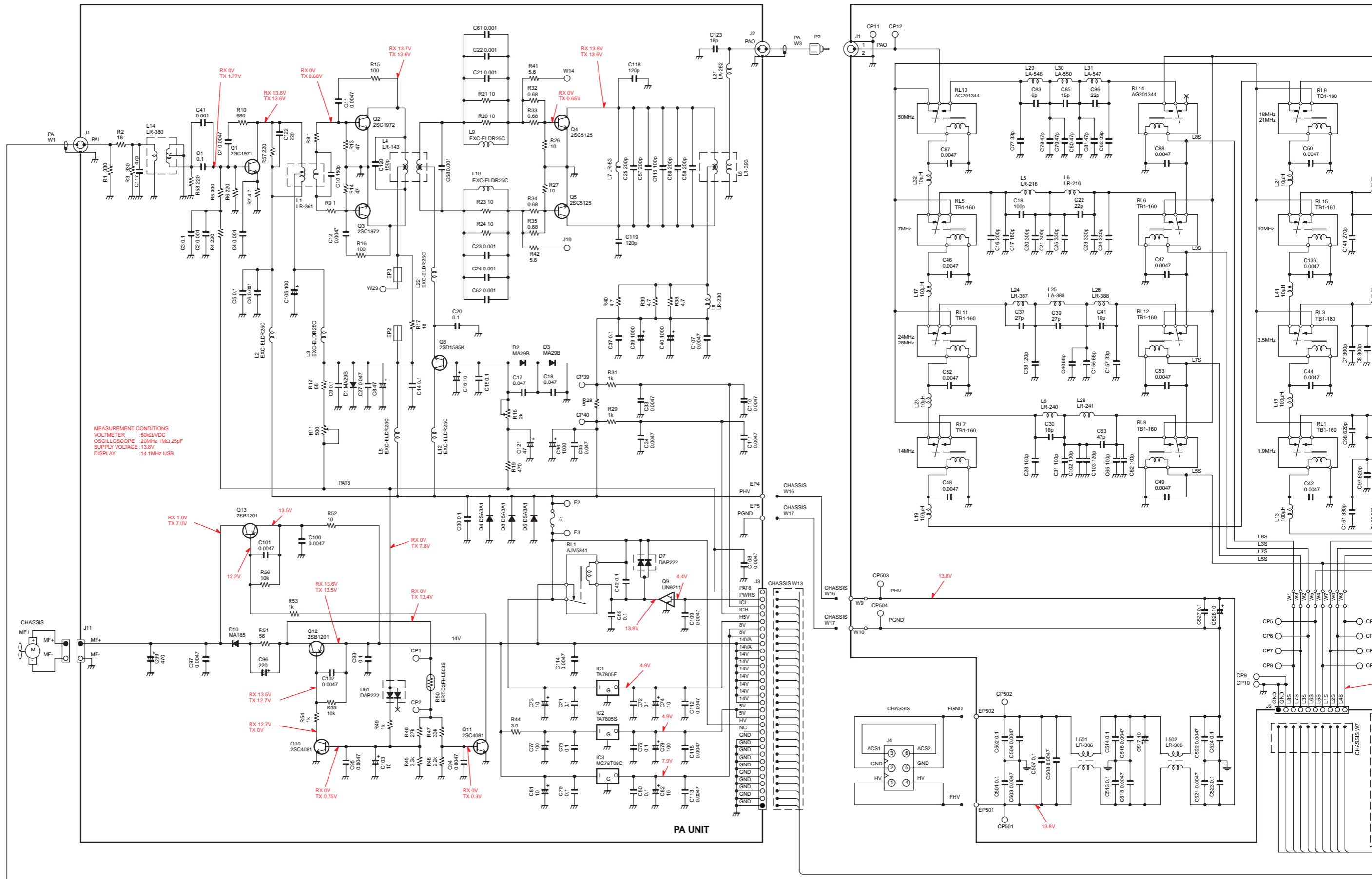

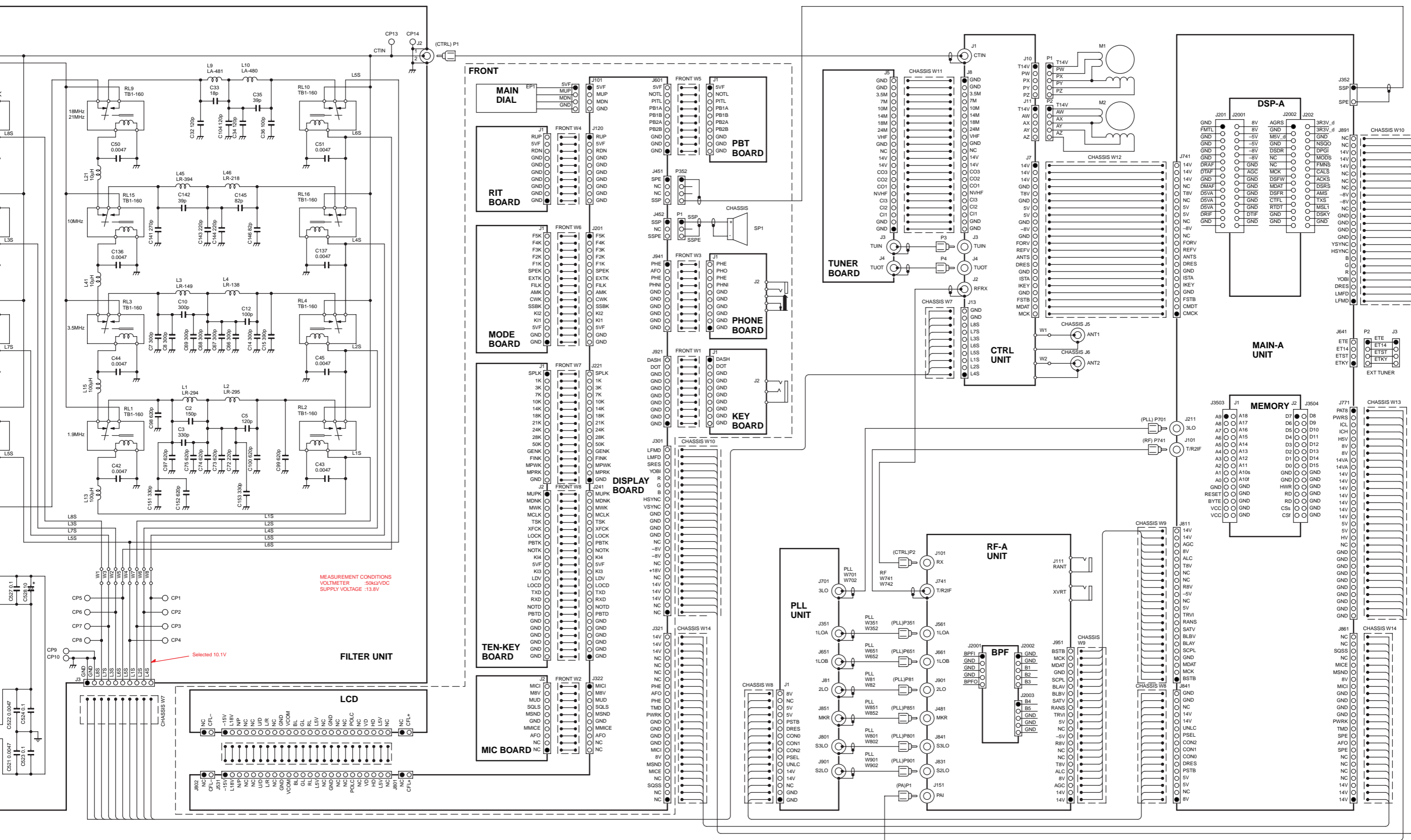

MEASUREMENT CONDITIONS
VOLTMETER: 50kΩ/VDC
SUPPLY VOLTAGE: 13.8V

Selected 10.1V

FRONT

MAIN DIAL

RIT BOARD

MODE BOARD

TEN-KEY BOARD

MIC BOARD

DISPLAY BOARD

PHONE BOARD

KEY BOARD

PBT BOARD

RF-A UNIT

PLL UNIT

CTRL UNIT

MEMORY

DSP-A

MAIN-A UNIT

FILTER UNIT

LCD

TUNER BOARD

CHASSIS W10

CHASSIS W11

CHASSIS W12

CHASSIS W13

CHASSIS W14

CHASSIS W9

CHASSIS W8

CHASSIS W7

CHASSIS W6

CHASSIS W5

CHASSIS W4

CHASSIS W3

CHASSIS W2

CHASSIS W1

CHASSIS W0

CHASSIS W

CHASSIS W

CHASSIS W

CHASSIS W

CHASSIS W

CHASSIS W

CHASSIS W

CHASSIS W

CHASSIS W

CHASSIS W

CHASSIS W

CHASSIS W

CHASSIS W

CHASSIS W

CHASSIS W

CHASSIS W

CHASSIS W

CHASSIS W

CHASSIS W

CHASSIS W

CHASSIS W

CHASSIS W

CHASSIS W

CHASSIS W

CHASSIS W

CHASSIS W

CHASSIS W

CHASSIS W

CHASSIS W

CHASSIS W

CHASSIS W

CHASSIS W

CHASSIS W

CHASSIS W

CHASSIS W

CHASSIS W

CHASSIS W

CHASSIS W

CHASSIS W

CHASSIS W

CHASSIS W

CHASSIS W

CHASSIS W

CHASSIS W

CHASSIS W

CHASSIS W

CHASSIS W

CHASSIS W

CHASSIS W

CHASSIS W

CHASSIS W

CHASSIS W

CHASSIS W

CHASSIS W

CHASSIS W

CHASSIS W

CHASSIS W

CHASSIS W

CHASSIS W

CHASSIS W

CHASSIS W

CHASSIS W

CHASSIS W

CHASSIS W

CHASSIS W

CHASSIS W

CHASSIS W

CHASSIS W

CHASSIS W

CHASSIS W

CHASSIS W

CHASSIS W

CHASSIS W

CHASSIS W

CHASSIS W

CHASSIS W

CHASSIS W

CHASSIS W

CHASSIS W

CHASSIS W

CHASSIS W

CHASSIS W

CHASSIS W

CHASSIS W

CHASSIS W

CHASSIS W

CHASSIS W

CHASSIS W

CHASSIS W

CHASSIS W

CHASSIS W

CHASSIS W

CHASSIS W

CHASSIS W

CHASSIS W

CHASSIS W

CHASSIS W

CHASSIS W

CHASSIS W

CHASSIS W

CHASSIS W

CHASSIS W

CHASSIS W

CHASSIS W

CHASSIS W

CHASSIS W

CHASSIS W

CHASSIS W

CHASSIS W

CHASSIS W

CHASSIS W

CHASSIS W

CHASSIS W

CHASSIS W

CHASSIS W

CHASSIS W

CHASSIS W

CHASSIS W

CHASSIS W

CHASSIS W

CHASSIS W

CHASSIS W

CHASSIS W

CHASSIS W

CHASSIS W

CHASSIS W

CHASSIS W

CHASSIS W

CHASSIS W

CHASSIS W

CHASSIS W

CHASSIS W

CHASSIS W

CHASSIS W

CHASSIS W

CHASSIS W

CHASSIS W

CHASSIS W

CHASSIS W

CHASSIS W

CHASSIS W

CHASSIS W

CHASSIS W

CHASSIS W

CHASSIS W

CHASSIS W

CHASSIS W

CHASSIS W

CHASSIS W

CHASSIS W

CHASSIS W

CHASSIS W

CHASSIS W

CHASSIS W

CHASSIS W

CHASSIS W

CHASSIS W

CHASSIS W

CHASSIS W

CHASSIS W

CHASSIS W

CHASSIS W

CHASSIS W

CHASSIS W

CHASSIS W

CHASSIS W

CHASSIS W

CHASSIS W

CHASSIS W

CHASSIS W

CHASSIS W

CHASSIS W

CHASSIS W

CHASSIS W

CHASSIS W

CHASSIS W

CHASSIS W

CHASSIS W

CHASSIS W

CHASSIS W

CHASSIS W

CHASSIS W

CHASSIS W

CHASSIS W

CHASSIS W

CHASSIS W

CHASSIS W

CHASSIS W

CHASSIS W

CHASSIS W

CHASSIS W

CHASSIS W

CHASSIS W

CHASSIS W

CHASSIS W

CHASSIS W

CHASSIS W

CHASSIS W

CHASSIS W

CHASSIS W

CHASSIS W

CHASSIS W

CHASSIS W

CHASSIS W

CHASSIS W

CHASSIS W

CHASSIS W

CHASSIS W

CHASSIS W

CHASSIS W

CHASSIS W

CHASSIS W

CHASSIS W

CHASSIS W

CHASSIS W

CHASSIS W

CHASSIS W

CHASSIS W

CHASSIS W

CHASSIS W

CHASSIS W

CHASSIS W

CHASSIS W

CHASSIS W

CHASSIS W

CHASSIS W

CHASSIS W

CHASSIS W

CHASSIS W

CHASSIS W

CHASSIS W

CHASSIS W

CHASSIS W

CHASSIS W

10-8 RF-A UNIT AND BPF BOARD

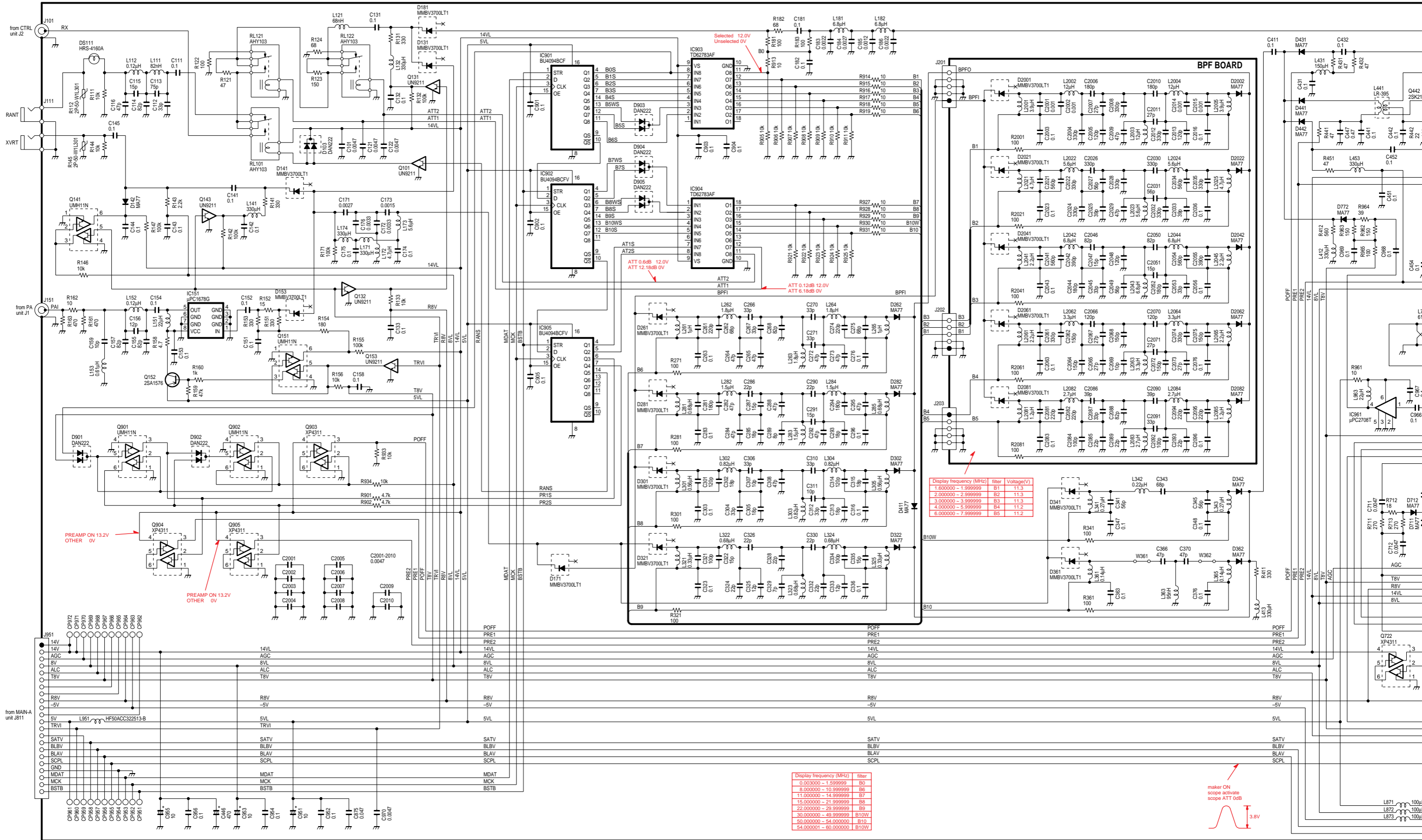

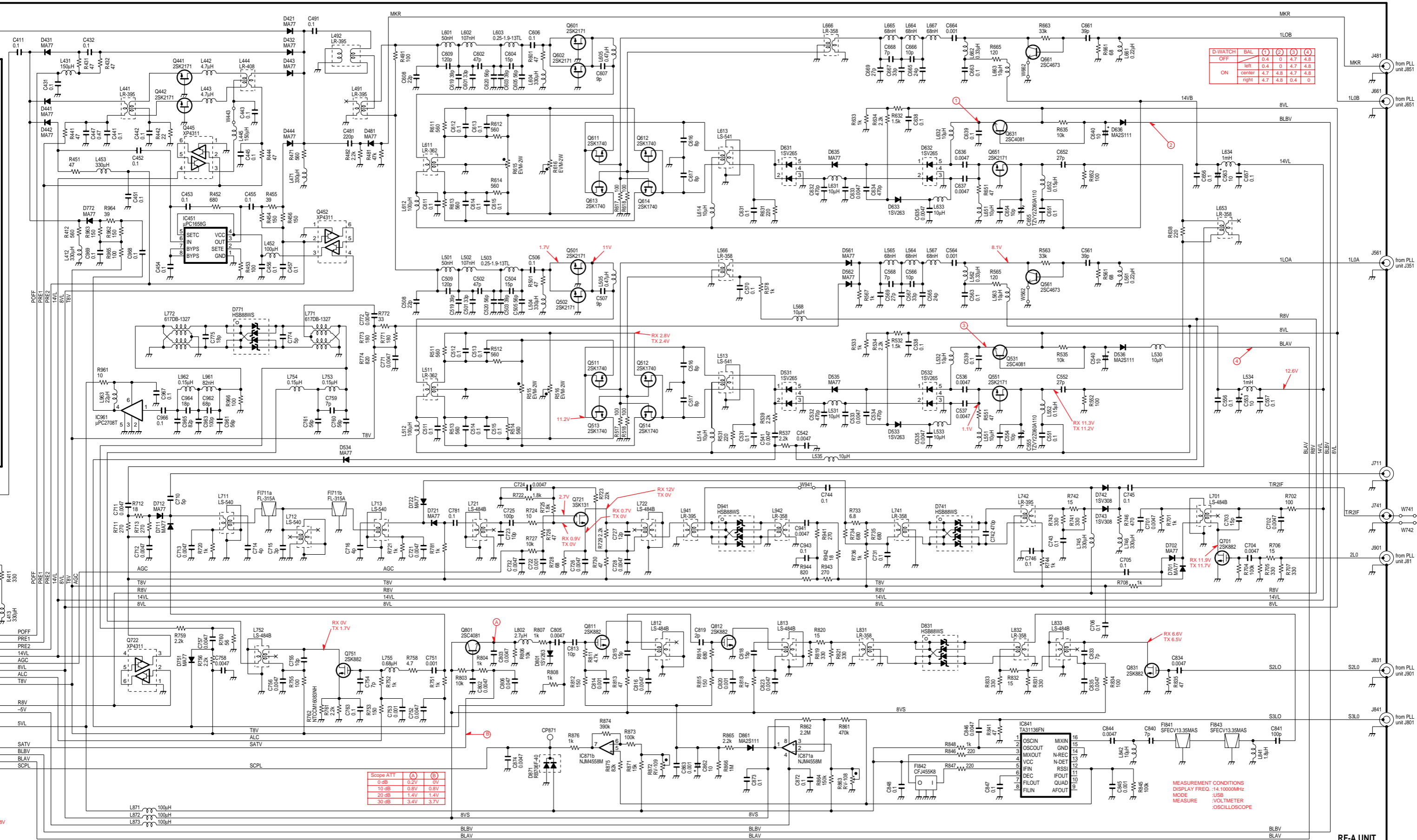

D-WATCH	BAL	(1)	(2)	(3)	(4)
OFF	0.4	0	4.7	4.8	
ON	left	4.7	4.8	4.7	4.8
	center	4.7	4.8	4.7	4.8
	right	4.7	4.8	0.4	0

Scope ATT	(A)	(B)
0 dB	0.2V	0V
10 dB	0.8V	0.8V
20 dB	1.4V	1.4V
30 dB	3.4V	3.7V

MEASUREMENT CONDITIONS
 DISPLAY FREQ.: 14.10000MHz
 MODE: USB
 MEASURE: VOLT-METER
 OSCILLOSCOPE

RF-A UNIT